































Ocak / January 2014





DELTA[®]

DELTA[®]

www.deltakalip.com

| | | | | | |
|---|---|---|--|---|---|
|  | D02 Kademeli Kolon Guide Pillar 2-11 |  | D22B Bilyalı Burç Guide Bush with Ball Cage 35 |  | D15 Kolon Guide Pillar 49-50 |
|  | D20 Burç Guide Bush 12-13 |  | D50 Konik Kilitleme Locating Unit 36 |  | D23 Burç Guide Bush 51 |
|  | D03 Kuyruklu Kolon Tailed Guide Pillar 14-21 |  | D00 Kolon Guide Pillar 38-39 |  | D24 Burç Guide Bush 52 |
|  | D21 Kuyruklu Burç Tailed Guide Bush 22-23 |  | D05 Kolon Guide Pillar 40-41 |  | D25 Bronzlu Burç Guide Bush with Bronze 53 |
|  | D40 Tespit Burcu Centring Sleeves 24-25 |  | D10 Kolon Guide Pillar 42 |  | D26 Bronzlu Burç Guide Bush with Bronze 54 |
|  | D01 Kolon Guide Pillar 26-28 |  | D11 Kolon Guide Pillar 43 |  | D32 Sinterli Burç Guide Bush with Sintered 55 |
|  | D22 Flanşlı Burç Middle Flanged Bush 29 |  | D12 Kolon Guide Pillar AFNOR 44 |  | D33 Sinterli Burç Guide Bush with Sintered 56 |
|  | D01D Kolon Guide Pillar 30-32 |  | D13.01 Kolon Guide Pillar 45 |  | D27 Burç Guide Bush 57 |
|  | D08 Kolon Guide Pillar 33 |  | D13.02 Kolon Guide Pillar 46 |  | D28 Burç Guide Bush 58 |
|  | D09 Kolon Guide Pillar 34 |  | D14 Kolon Guide Pillar 47-48 |  | D60 Bilyalı Kafes Ball Cage 59-61 |

| | | | | | |
|---|---|---|--|---|--|
|  | D60.01 Bilyalı Kafes Tutucusu Helical Spring for Ball Cage Retention 62 |  | D80.04 Grafitli Sürtünme Plakası Wear Plate with Graphite Insert 76 |  | D100.50.01_00750 Gazlı Yay Bağlama Pabucu Gas Springs Mounting Clamp 87 |
|  | D30.01 Grafitli Burç Oilless Guide Bush 63 |  | D80.15 Çelik Sürtünme Plakası Sliding Pads 77-78 |  | D100.50.02_00750 Gazlı Yay Bağlama Pabucu Gas Springs Mounting Clamp 87 |
|  | D30.02 Grafitli Burç Oilless Guide Bush 64 |  | D88 Düz Kam Horizontal Slide Cam Unit 79 |  | D100.01_01500 Gazlı Yay Gas Springs 88 |
|  | D30.03 Grafitli Burç Oilless Guide Bush AFNOR 65 |  | D100.01_00250 Gazlı Yay Gas Springs 82 |  | D100.50.01_01500 Gazlı Yay Bağlama Pabucu Gas Springs Mounting Clamp 89 |
|  | D30.04 Grafitli Burç Oilless Guide Bush 66-68 |  | D100.50.01_00250 Gazlı Yay Bağlama Pabucu Gas Springs Mounting Clamp 83 |  | D100.50.02_01500 Gazlı Yay Bağlama Pabucu Gas Springs Mounting Clamp 89 |
|  | D30.05 Grafitli Burç Oilless Guide Bush 69-70 |  | D100.50.02_00250 Gazlı Yay Bağlama Pabucu Gas Springs Mounting Clamp 83 |  | D100.01_03000 Gazlı Yay Gas Springs 90 |
|  | D30.06 Grafitli Burç Oilless Guide Bush 71 |  | D100.01_00500 Gazlı Yay Gas Springs 84 |  | D100.50.01_03000 Gazlı Yay Bağlama Pabucu Gas Springs Mounting Clamp 91 |
|  | D80.01 Grafitli Sürtünme Plakası Wear Plate with Graphite Insert 72 |  | D100.50.01_00500 Gazlı Yay Bağlama Pabucu Gas Springs Mounting Clamp 85 |  | D100.50.02_03000 Gazlı Yay Bağlama Pabucu Gas Springs Mounting Clamp 91 |
|  | D80.02 Grafitli Sürtünme Plakası Wear Plate with Graphite Insert 73 |  | D100.50.02_00500 Gazlı Yay Bağlama Pabucu Gas Springs Mounting Clamp 85 |  | D100.01_05000 Gazlı Yay Gas Springs 92 |
|  | D80.03 Grafitli Sürtünme Plakası Wear Plate with Graphite Insert 74-75 |  | D100.01_00750 Gazlı Yay Gas Springs 86 |  | D100.50.01_05000 Gazlı Yay Bağlama Pabucu Gas Springs Mounting Clamp 93 |

| | | | | | |
|---|--|---|--|---|--|
|  | D100.50.02_05000 Gazlı Yay Bağlama Pabucu Gas Springs Mounting Clamp 93 |  | D100.02_01500 Gazlı Yay Gas Springs 101 |  | D100.50.02_05000 Gazlı Yay Bağlama Pabucu Gas Springs Mounting Clamp 108 |
|  | D100.02_00320 Gazlı Yay Gas Springs 94 |  | D100.50.01_01000 Gazlı Yay Bağlama Pabucu Gas Springs Mounting Clamp 102 |  | D70.01 Döküm Blok Guide Bearing 109 |
|  | D100.02_00350 Gazlı Yay Gas Springs 95 |  | D100.02_02400 Gazlı Yay Gas Springs 103 |  | D70.02 Bronzlu Döküm Blok Guide Bearing with Bronze 110 |
|  | D100.02_00500 Gazlı Yay Gas Springs 96 |  | D100.50.01_01500 Gazlı Yay Bağlama Pabucu Gas Springs Mounting Clamp 104 |  | D70.03 Çelik Kaymalı Döküm Blok Guide Bearing with Steel 111 |
|  | D100.02_00750 Gazlı Yay Gas Springs 97 |  | D100.50.02_01500 Gazlı Yay Bağlama Pabucu Gas Springs Mounting Clamp 104 |  | D70.04 Bilyalı Döküm Blok Guide Bearing with Ball Cage 112 |
|  | D100.50.01_00500 Gazlı Yay Bağlama Pabucu Gas Springs Mounting Clamp 98 |  | D100.02_04200 Gazlı Yay Gas Springs 105 |  | D70.05 Grafitli Döküm Blok Guide Bearing Non-Lubricant 113 |
|  | D100.50.02_00500 Gazlı Yay Bağlama Pabucu Gas Springs Mounting Clamp 98 |  | D100.50.01_03000 Gazlı Yay Bağlama Pabucu Gas Springs Mounting Clamp 106 |  | D70.10 Kolon Sabitleme Bloğu Pillar Bearing 114 |
|  | D100.02_01000 Gazlı Yay Gas Springs 99 |  | D100.50.02_03000 Gazlı Yay Bağlama Pabucu Gas Springs Mounting Clamp 106 |  | D70.011 Döküm Set Guide Bearing Set 115 |
|  | D100.50.01_00750 Gazlı Yay Bağlama Pabucu Gas Springs Mounting Clamp 100 |  | D100.02_06600 Gazlı Yay Gas Springs 107 |  | D70.021 Bronzlu Döküm Set Guide Bearing Set with Bronze 116 |
|  | D100.50.02_00750 Gazlı Yay Bağlama Pabucu Gas Springs Mounting Clamp 100 |  | D100.50.01_05000 Gazlı Yay Bağlama Pabucu Gas Springs Mounting Clamp 108 |  | D70.031 Çelik Kaymalı Döküm Set Guide Bearing Set with Steel 117 |

| | | | |
|---|--|---|---|
|  | D70.041 Bilyalı Döküm Set Guide Bearing Set with Ball Cage 118 |  | D19.50 Emniyet Mili Pad Retainer Pin 128 |
|  | D70.051 Grafitli Döküm Set Guide Bearing Set Non-Lubricant 119 |  | D12.01 Kolon Tutucu Flaş Clamping Flange AFNOR 129 |
|  | D71.02 Bronzlu Döküm Blok Guide Bearing with Bronze 120 |  | D12.02 Tutucu Halka Retaining Ring AFNOR 130 |
|  | D71.05 Grafitli Döküm Blok Guide Bearing Non-Lubricant 121 |  | D30.03.01 Burç Tutucu Flaş Retaining Flange AFNOR 131 |
|  | D71.10 Kolon Sabitleme Bloğu Pillar Bearing 122 |  | D90 Bağlama Pabucu Pillar and Bush Clamp 132 |
|  | D71.021 Bronzlu Döküm Set Guide Bearing Set with Bronze 123 |  | D90.01 Bağlama Pabucu Pillar and Bush Clamp 133 |
|  | D71.051 Grafitli Döküm Set Guide Bearing Set Non-Lubricant 124 | Teknik Bilgiler | 134-135 |
|  | D19.01 Taşıma Mili Lifting Pins 125 | İndeks | 136 |
|  | D19.02 Taşıma Mili Lifting Pins 126 | | |
|  | D19.03 Taşıma Mili Lifting Pins 127 | | |

Enjeksiyon Kalıbı Ürünleri

Injection Mould Components

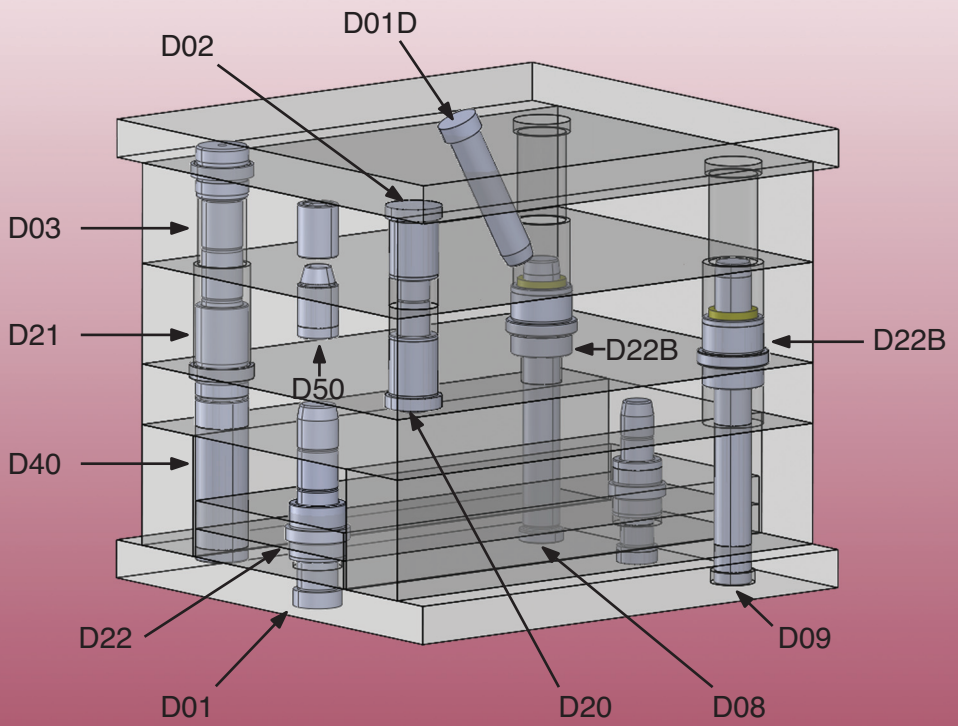

D02

Kademeli Kolon / Guide Pillar

Malzeme - Material : Asil Çelik 1.1213 (Cf 53)
 Sertlik - Hardness : 62± 2 HRC
 Isil İşlem - Heat Treatment : İndüksiyon (Induction)



| Ø | | | | | | |
|--------------|----|----|-----|----|----|---|
| Sipariş Kodu | d1 | L1 | L2 | d2 | d3 | a |
| D02_12026026 | 12 | 26 | 26 | 16 | 19 | 4 |
| 036 | | | 36 | | | |
| 046 | | | 46 | | | |
| 056 | | | 56 | | | |
| D02_12036026 | 12 | 36 | 26 | 16 | 19 | 4 |
| 036 | | | 36 | | | |
| 046 | | | 46 | | | |
| 056 | | | 56 | | | |
| D02_12046026 | 12 | 46 | 26 | 16 | 19 | 4 |
| 036 | | | 36 | | | |
| 046 | | | 46 | | | |
| 056 | | | 56 | | | |
| 066 | | | 66 | | | |
| D02_14026026 | 14 | 26 | 26 | 20 | 25 | 6 |
| 036 | | | 36 | | | |
| 046 | | | 46 | | | |
| 056 | | | 56 | | | |
| 066 | | | 66 | | | |
| 076 | | | 76 | | | |
| D02_14036026 | 14 | 36 | 26 | 20 | 25 | 6 |
| 036 | | | 36 | | | |
| 046 | | | 46 | | | |
| 056 | | | 56 | | | |
| 066 | | | 66 | | | |
| 086 | | | 86 | | | |
| D02_14046026 | 14 | 46 | 26 | 20 | 25 | 6 |
| 036 | | | 36 | | | |
| 046 | | | 46 | | | |
| 056 | | | 56 | | | |
| 076 | | | 76 | | | |
| 096 | | | 96 | | | |
| D02_14056026 | 14 | 56 | 26 | 20 | 25 | 6 |
| 036 | | | 36 | | | |
| 046 | | | 46 | | | |
| 066 | | | 66 | | | |
| 086 | | | 86 | | | |
| 106 | | | 106 | | | |
| D02_16026026 | 16 | 26 | 26 | 24 | 28 | 6 |
| 036 | | | 36 | | | |
| 046 | | | 46 | | | |
| 056 | | | 56 | | | |
| 076 | | | 76 | | | |

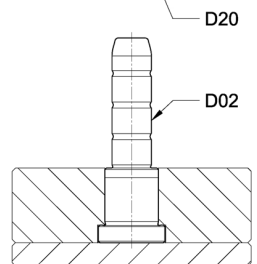
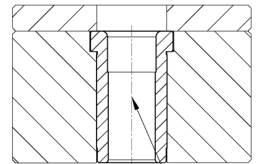
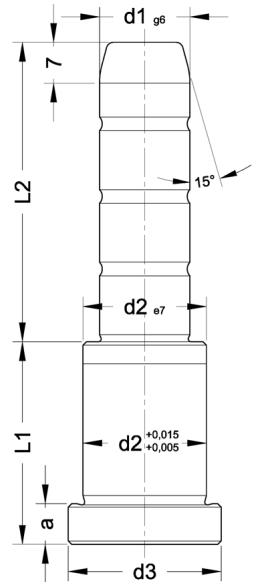

D02

Kademeli Kolon / Guide Pillar

Malzeme - Material : Asil Çelik 1.1213 (Cf 53)
 Sertlik - Hardness : 62 ± 2 HRC
 Isil İşlem - Heat Treatment : İndüksiyon (Induction)



| Sipariş Kodu | Ø d1 | L1 | L2 | d2 | d3 | a |
|--------------|------|----|-----|----|----|---|
| D02_16026096 | 16 | 26 | 96 | 24 | 28 | 6 |
| D02_16036026 | 16 | 36 | 26 | 24 | 28 | 6 |
| 036 | | | 36 | | | |
| 046 | | | 46 | | | |
| 056 | | | 56 | | | |
| 066 | | | 66 | | | |
| 086 | | | 86 | | | |
| 106 | | | 106 | | | |
| D02_16046026 | 16 | 46 | 26 | 24 | 28 | 6 |
| 036 | | | 36 | | | |
| 046 | | | 46 | | | |
| 056 | | | 56 | | | |
| 066 | | | 66 | | | |
| 076 | | | 76 | | | |
| 096 | | | 96 | | | |
| 116 | | | 116 | | | |
| D02_16056026 | 16 | 56 | 26 | 24 | 28 | 6 |
| 036 | | | 36 | | | |
| 046 | | | 46 | | | |
| 056 | | | 56 | | | |
| 066 | | | 66 | | | |
| 076 | | | 76 | | | |
| 096 | | | 96 | | | |
| 116 | | | 116 | | | |
| D02_16066026 | 16 | 66 | 26 | 24 | 28 | 6 |
| 036 | | | 36 | | | |
| 046 | | | 46 | | | |
| 056 | | | 56 | | | |
| 066 | | | 66 | | | |
| 076 | | | 76 | | | |
| 086 | | | 86 | | | |
| 106 | | | 106 | | | |
| 116 | | | 116 | | | |
| D02_16076026 | 16 | 76 | 26 | 24 | 28 | 6 |
| 036 | | | 36 | | | |
| 046 | | | 46 | | | |
| 056 | | | 56 | | | |
| 066 | | | 66 | | | |
| 076 | | | 76 | | | |
| 096 | | | 96 | | | |
| 116 | | | 116 | | | |
| D02_16086026 | 16 | 86 | 26 | 24 | 28 | 6 |

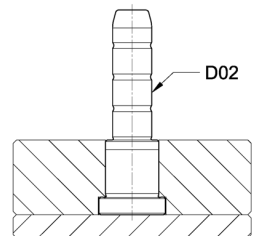
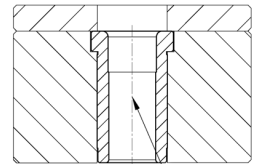
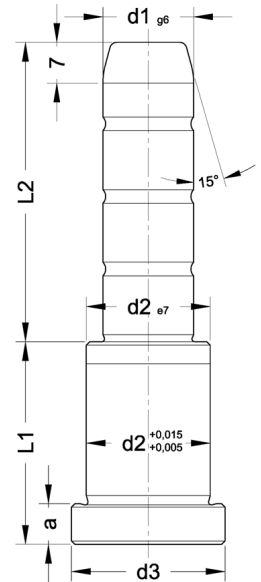

D02

Kademeli Kolon / Guide Pillar

Malzeme - Material : Asil Çelik 1.1213 (Cf 53)
 Sertlik - Hardness : 62 ± 2 HRC
 Isil İşlem - Heat Treatment : İndüksiyon (Induction)



| | Ø | | | | | |
|--------------|----|----|-----|----|----|---|
| Sipariş Kodu | d1 | L1 | L2 | d2 | d3 | a |
| D02_16086036 | 16 | 86 | 36 | 24 | 28 | 6 |
| 046 | | | 46 | | | |
| 056 | | | 56 | | | |
| 066 | | | 66 | | | |
| 076 | | | 76 | | | |
| 096 | | | 96 | | | |
| 116 | | | 116 | | | |
| D02_18026026 | 18 | 26 | 26 | 26 | 31 | 6 |
| 036 | | | 36 | | | |
| 046 | | | 46 | | | |
| 056 | | | 56 | | | |
| 066 | | | 66 | | | |
| 086 | | | 86 | | | |
| D02_18036026 | 18 | 36 | 26 | 26 | 31 | 6 |
| 036 | | | 36 | | | |
| 046 | | | 46 | | | |
| 056 | | | 56 | | | |
| 066 | | | 66 | | | |
| 086 | | | 86 | | | |
| 106 | | | 106 | | | |
| D02_18046026 | 18 | 46 | 26 | 26 | 31 | 6 |
| 036 | | | 36 | | | |
| 046 | | | 46 | | | |
| 056 | | | 56 | | | |
| 066 | | | 66 | | | |
| 086 | | | 86 | | | |
| 106 | | | 106 | | | |
| 126 | | | 126 | | | |
| D02_18056026 | 18 | 56 | 26 | 26 | 31 | 6 |
| 036 | | | 36 | | | |
| 046 | | | 46 | | | |
| 056 | | | 56 | | | |
| 066 | | | 66 | | | |
| 086 | | | 86 | | | |
| 106 | | | 106 | | | |
| 126 | | | 126 | | | |
| D02_18066026 | 18 | 66 | 26 | 26 | 31 | 6 |
| 036 | | | 36 | | | |
| 056 | | | 56 | | | |
| 076 | | | 76 | | | |
| 096 | | | 96 | | | |
| 116 | | | 116 | | | |

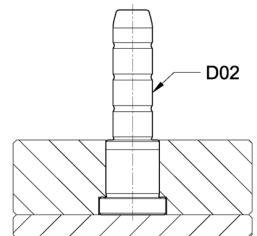
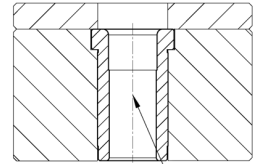
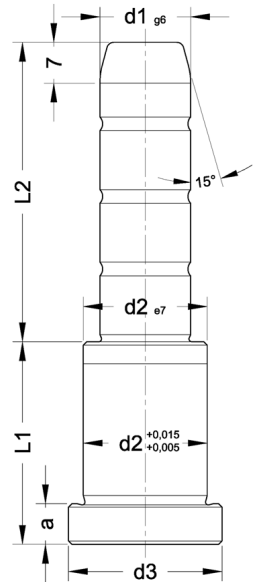

D02

Kademeli Kolon / Guide Pillar

Malzeme - Material : Asil Çelik 1.1213 (Cf 53)
 Sertlik - Hardness : 62 ± 2 HRC
 Isil İşlem - Heat Treatment : İndüksiyon (Induction)



| | Ø | | | | | |
|--------------|----|----|----|----|----|----|
| Sipariş Kodu | d1 | L1 | L2 | d2 | d3 | a |
| D02_18076026 | 18 | 76 | 26 | 26 | 31 | 6 |
| 046 | | | | | | |
| 066 | | | | | | |
| 086 | | | | | | |
| 106 | | | | | | |
| 126 | | | | | | |
| D02_18086026 | | | 18 | | | |
| 046 | | | | | | |
| 066 | | | | | | |
| 086 | | | | | | |
| 106 | | | | | | |
| 126 | | | | | | |
| D02_20026026 | 20 | 26 | | 26 | 28 | 32 |
| 036 | | | | | | |
| 046 | | | | | | |
| 056 | | | | | | |
| 066 | | | | | | |
| 086 | | | | | | |
| D02_20036026 | | | 20 | 36 | | |
| 036 | | | | | | |
| 046 | | | | | | |
| 056 | | | | | | |
| 066 | | | | | | |
| 076 | | | | | | |
| 096 | | | | | | |
| D02_20046026 | 20 | 46 | 26 | 28 | 32 | 6 |
| 036 | | | | | | |
| 046 | | | | | | |
| 056 | | | | | | |
| 066 | | | | | | |
| 076 | | | | | | |
| 086 | | | | | | |
| D02_20056026 | 20 | 56 | 26 | 28 | 32 | 6 |
| 036 | | | | | | |
| 046 | | | | | | |
| 056 | | | | | | |
| 066 | | | | | | |
| 076 | | | | | | |
| 096 | | | | | | |
| D02_20066026 | 20 | 66 | 26 | 28 | 32 | 6 |

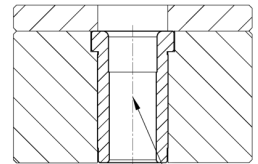
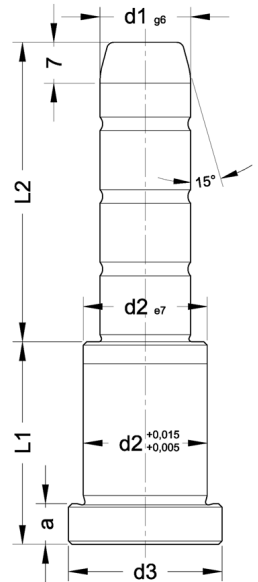

D20

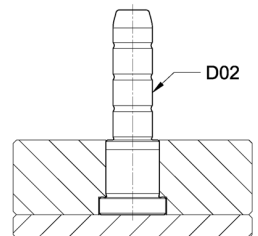

D02

D02

Kademeli Kolon / Guide Pillar

Malzeme - Material : Asil Çelik 1.1213 (Cf 53)
 Sertlik - Hardness : 62 ± 2 HRC
 Isil İşlem - Heat Treatment : İndüksiyon (Induction)



| | Ø | | | | | |
|--------------|----|----|-----|----|----|---|
| Sipariş Kodu | d1 | L1 | L2 | d2 | d3 | a |
| D02_20066036 | 20 | 66 | 36 | 28 | 32 | 6 |
| 046 | | | 46 | | | |
| 056 | | | 56 | | | |
| 066 | | | 66 | | | |
| 076 | | | 76 | | | |
| 096 | | | 96 | | | |
| 116 | | | 116 | | | |
| D02_20076026 | 20 | 76 | 26 | 28 | 32 | 6 |
| 036 | | | 36 | | | |
| 046 | | | 46 | | | |
| 056 | | | 56 | | | |
| 066 | | | 66 | | | |
| 076 | | | 76 | | | |
| 086 | | | 86 | | | |
| 106 | | | 106 | | | |
| 126 | | | 126 | | | |
| D02_20086026 | 20 | 86 | 26 | 28 | 32 | 6 |
| 036 | | | 36 | | | |
| 046 | | | 46 | | | |
| 056 | | | 56 | | | |
| 066 | | | 66 | | | |
| 076 | | | 76 | | | |
| 086 | | | 86 | | | |
| 106 | | | 106 | | | |
| 126 | | | 126 | | | |
| D02_20096026 | 20 | 96 | 26 | 28 | 32 | 6 |
| 036 | | | 36 | | | |
| 046 | | | 46 | | | |
| 056 | | | 56 | | | |
| 066 | | | 66 | | | |
| 076 | | | 76 | | | |
| 086 | | | 86 | | | |
| 106 | | | 106 | | | |
| 126 | | | 126 | | | |
| D02_25026026 | 25 | 26 | 26 | 34 | 38 | 8 |
| 036 | | | 36 | | | |
| 046 | | | 46 | | | |
| 056 | | | 56 | | | |
| 066 | | | 66 | | | |
| 076 | | | 76 | | | |
| 096 | | | 96 | | | |
| D02_25036026 | 25 | 36 | 26 | 34 | 38 | 8 |

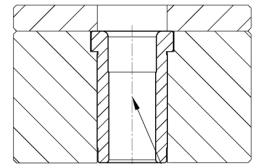
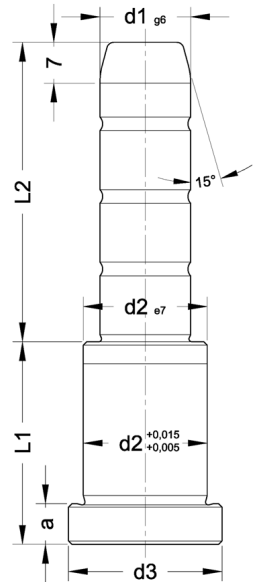

D20

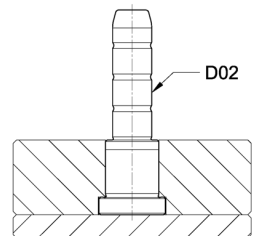

D02

D02

Kademeli Kolon / Guide Pillar

Malzeme - Material : Asil Çelik 1.1213 (Cf 53)
 Sertlik - Hardness : 62± 2 HRC
 Isıl İşlem - Heat Treatment : İndüksiyon (Induction)



| | Ø | | | | | |
|--------------|----|----|-----|----|----|---|
| Sipariş Kodu | d1 | L1 | L2 | d2 | d3 | a |
| D02_25036036 | 25 | 36 | 36 | 34 | 38 | 8 |
| 046 | | | 46 | | | |
| 056 | | | 56 | | | |
| 066 | | | 66 | | | |
| 076 | | | 76 | | | |
| 086 | | | 86 | | | |
| 106 | | | 106 | | | |
| D02_25046026 | 25 | 46 | 26 | 34 | 38 | 8 |
| 036 | | | 36 | | | |
| 046 | | | 46 | | | |
| 056 | | | 56 | | | |
| 066 | | | 66 | | | |
| 076 | | | 76 | | | |
| 096 | | | 96 | | | |
| 116 | | | 116 | | | |
| D02_25056026 | 25 | 56 | 26 | 34 | 38 | 8 |
| 036 | | | 36 | | | |
| 046 | | | 46 | | | |
| 056 | | | 56 | | | |
| 066 | | | 66 | | | |
| 076 | | | 76 | | | |
| 096 | | | 96 | | | |
| 116 | | | 116 | | | |
| D02_25066026 | 25 | 66 | 26 | 34 | 38 | 8 |
| 036 | | | 36 | | | |
| 046 | | | 46 | | | |
| 056 | | | 56 | | | |
| 066 | | | 66 | | | |
| 076 | | | 76 | | | |
| 086 | | | 86 | | | |
| 106 | | | 106 | | | |
| 126 | | | 126 | | | |
| D02_25076026 | 25 | 76 | 26 | 34 | 38 | 8 |
| 036 | | | 36 | | | |
| 046 | | | 46 | | | |
| 056 | | | 56 | | | |
| 066 | | | 66 | | | |
| 076 | | | 76 | | | |
| 086 | | | 86 | | | |
| 106 | | | 106 | | | |
| 126 | | | 126 | | | |
| D02_25086036 | 25 | 86 | 36 | 34 | 38 | 8 |

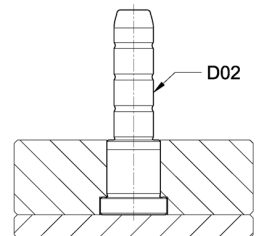
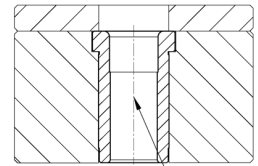
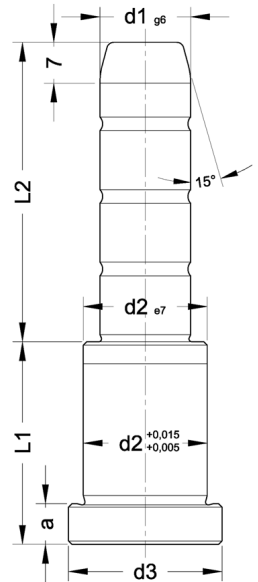

D02

Kademeli Kolon / Guide Pillar

Malzeme - Material : Asil Çelik 1.1213 (Cf 53)
 Sertlik - Hardness : 62± 2 HRC
 Isil İşlem - Heat Treatment : İndüksiyon (Induction)



| | Ø | | | | | |
|--------------|----|-----|-----|----|----|----|
| Sipariş Kodu | d1 | L1 | L2 | d2 | d3 | a |
| D02_25086046 | 25 | 86 | 46 | 34 | 38 | 8 |
| 056 | | | 56 | | | |
| 066 | | | 66 | | | |
| 076 | | | 76 | | | |
| 086 | | | 86 | | | |
| 096 | | | 96 | | | |
| 116 | | | 116 | | | |
| 136 | | | 136 | | | |
| D02_25096036 | 25 | 96 | 36 | 34 | 38 | 8 |
| 046 | | | 46 | | | |
| 056 | | | 56 | | | |
| 066 | | | 66 | | | |
| 076 | | | 76 | | | |
| 086 | | | 86 | | | |
| 096 | | | 96 | | | |
| 116 | | | 116 | | | |
| 136 | | | 136 | | | |
| D02_25106046 | 25 | 106 | 46 | 34 | 38 | 8 |
| 056 | | | 56 | | | |
| 066 | | | 66 | | | |
| 076 | | | 76 | | | |
| 086 | | | 86 | | | |
| 096 | | | 96 | | | |
| 116 | | | 116 | | | |
| 136 | | | 136 | | | |
| D02_30036036 | 30 | 36 | 36 | 39 | 43 | 10 |
| 046 | | | 46 | | | |
| 056 | | | 56 | | | |
| 066 | | | 66 | | | |
| 086 | | | 86 | | | |
| 106 | | | 106 | | | |
| D02_30046036 | 30 | 46 | 36 | 39 | 43 | 10 |
| 046 | | | 46 | | | |
| 056 | | | 56 | | | |
| 066 | | | 66 | | | |
| 076 | | | 76 | | | |
| 096 | | | 96 | | | |
| 116 | | | 116 | | | |
| D02_30056036 | 30 | 56 | 36 | 39 | 43 | 10 |
| 046 | | | 46 | | | |
| 056 | | | 56 | | | |
| 066 | | | 66 | | | |

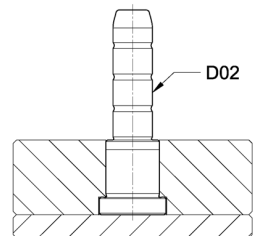
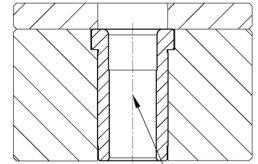
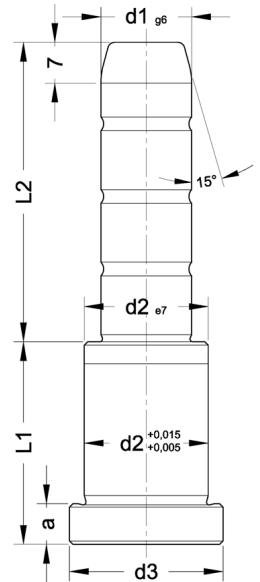

D02

Kademeli Kolon / Guide Pillar

Malzeme - Material : Asil Çelik 1.1213 (Cf 53)
 Sertlik - Hardness : 62± 2 HRC
 Isıl İşlem - Heat Treatment : İndüksiyon (Induction)



| | Ø | | | | | |
|--------------|-----|-----|-----|----|----|----|
| Sipariş Kodu | d1 | L1 | L2 | d2 | d3 | a |
| D02_30056076 | 30 | 56 | 76 | 39 | 43 | 10 |
| 086 | | | 86 | | | |
| 106 | | | 106 | | | |
| 126 | | | 126 | | | |
| D02_30066036 | 30 | 66 | 36 | 39 | 43 | 10 |
| 046 | | | 46 | | | |
| 056 | | | 56 | | | |
| 066 | | | 66 | | | |
| 076 | | | 76 | | | |
| 086 | | | 86 | | | |
| 096 | | | 96 | | | |
| 116 | | | 116 | | | |
| 136 | | | 136 | | | |
| D02_30076036 | | | 30 | | | |
| 046 | 46 | | | | | |
| 056 | 56 | | | | | |
| 076 | 76 | | | | | |
| 096 | 96 | | | | | |
| 116 | 116 | | | | | |
| 136 | 136 | | | | | |
| D02_30086036 | 30 | 86 | 36 | 39 | 43 | 10 |
| 046 | | | 46 | | | |
| 066 | | | 66 | | | |
| 086 | | | 86 | | | |
| 106 | | | 106 | | | |
| 126 | | | 126 | | | |
| 146 | | | 146 | | | |
| D02_30096046 | 30 | 96 | 46 | 39 | 43 | 10 |
| 066 | | | 66 | | | |
| 086 | | | 86 | | | |
| 106 | | | 106 | | | |
| 126 | | | 126 | | | |
| 146 | | | 146 | | | |
| D02_30106056 | 30 | 106 | 56 | 39 | 43 | 10 |
| 076 | | | 76 | | | |
| 096 | | | 96 | | | |
| 116 | | | 116 | | | |
| 136 | | | 136 | | | |
| D02_30116056 | 30 | 116 | 56 | 39 | 43 | 10 |
| 076 | | | 76 | | | |
| 096 | | | 96 | | | |
| 116 | | | 116 | | | |

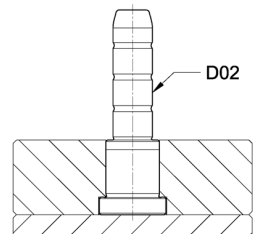
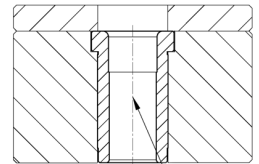
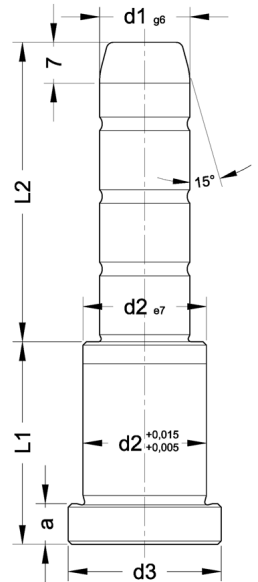

D02

Kademeli Kolon / Guide Pillar

Malzeme - Material : Asil Çelik 1.1213 (Cf 53)
 Sertlik - Hardness : 62± 2 HRC
 Isıl İşlem - Heat Treatment : İndüksiyon (Induction)



| | Ø | | | | | |
|--------------|----|-----|-----|----|----|----|
| Sipariş Kodu | d1 | L1 | L2 | d2 | d3 | a |
| D02_30116136 | 30 | 116 | 136 | 39 | 43 | 10 |
| D02_40056056 | 40 | 56 | 56 | 54 | 58 | 10 |
| 086 | | | 86 | | | |
| 106 | | | 106 | | | |
| 126 | | | 126 | | | |
| 156 | | | 156 | | | |
| 186 | | | 186 | | | |
| D02_40066066 | 40 | 66 | 66 | 54 | 58 | 10 |
| 096 | | | 96 | | | |
| 116 | | | 116 | | | |
| 136 | | | 136 | | | |
| 166 | | | 166 | | | |
| 196 | | | 196 | | | |
| D02_40076076 | 40 | 76 | 76 | 54 | 58 | 10 |
| 106 | | | 106 | | | |
| 126 | | | 126 | | | |
| 146 | | | 146 | | | |
| 166 | | | 166 | | | |
| 196 | | | 196 | | | |
| 216 | | | 216 | | | |
| D02_40086086 | 40 | 86 | 86 | 54 | 58 | 10 |
| 126 | | | 126 | | | |
| 146 | | | 146 | | | |
| 176 | | | 176 | | | |
| 206 | | | 206 | | | |
| 226 | | | 226 | | | |
| D02_40096096 | 40 | 96 | 96 | 54 | 58 | 10 |
| 136 | | | 136 | | | |
| 156 | | | 156 | | | |
| 186 | | | 186 | | | |
| 216 | | | 216 | | | |
| 236 | | | 236 | | | |
| D02_40106106 | 40 | 106 | 106 | 54 | 58 | 10 |
| 126 | | | 126 | | | |
| 156 | | | 156 | | | |
| 186 | | | 186 | | | |
| 226 | | | 226 | | | |
| 246 | | | 246 | | | |
| D02_40116116 | 40 | 116 | 116 | 54 | 58 | 10 |
| 136 | | | 136 | | | |
| 166 | | | 166 | | | |
| 196 | | | 196 | | | |

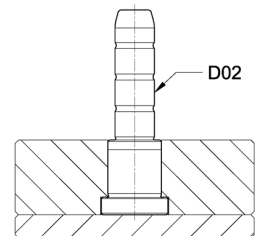
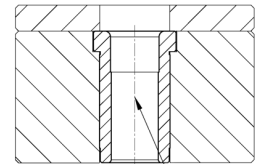
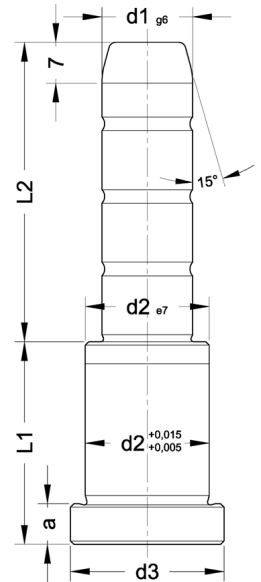

D02

Kademeli Kolon / Guide Pillar

Malzeme - Material : Asil Çelik 1.1213 (Cf 53)
 Sertlik - Hardness : 62 ± 2 HRC
 Isil İşlem - Heat Treatment : İndüksiyon (Induction)



| Sipariş Kodu | d1 | L1 | L2 | d2 | d3 | a |
|--------------|----|-----|-----|----|----|----|
| D02_40116236 | 40 | 116 | 236 | 54 | 58 | 10 |
| 256 | | | 256 | | | |
| D02_40126126 | 40 | 126 | 126 | 54 | 58 | 10 |
| 166 | | | 166 | | | |
| 196 | | | 196 | | | |
| 236 | | | 236 | | | |
| 266 | | | 266 | | | |
| D02_40136136 | 40 | 136 | 136 | 54 | 58 | 10 |
| 196 | | | 196 | | | |
| 226 | | | 226 | | | |
| 266 | | | 266 | | | |

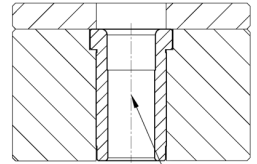
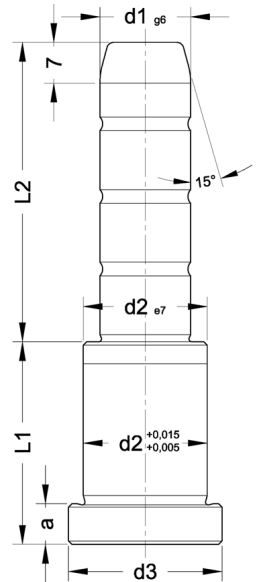

D20

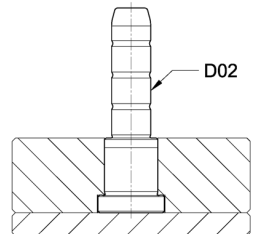

D02

D20

Burç / Guide Bush

Malzeme - Material : Asil Çelik 1.7131 (16MnCr5)
 Sertlik - Hardness : 62± 2 HRC
 Isıl İşlem - Heat Treatment : Sementasyon (Case Hardened)



| Sipariş Kodu | Ø d1 | L | d2 | d3 | a |
|--------------|---------|-----|----|----|---|
| D20_12026 | 12 | 26 | 16 | 19 | 4 |
| 036 | | 36 | | | |
| 046 | | 46 | | | |
| 056 | | 56 | | | |
| 066 | | 66 | | | |
| D20_14026 | 14 | 26 | 20 | 25 | 6 |
| 036 | | 36 | | | |
| 046 | | 46 | | | |
| 056 | | 56 | | | |
| 066 | | 66 | | | |
| 076 | | 76 | | | |
| D20_16026 | 16 | 26 | 24 | 28 | 6 |
| 036 | | 36 | | | |
| 046 | | 46 | | | |
| 056 | | 56 | | | |
| 066 | | 66 | | | |
| 076 | | 76 | | | |
| 086 | | 86 | | | |
| D20_18026 | 18 | 26 | 26 | 31 | 6 |
| 036 | | 36 | | | |
| 046 | | 46 | | | |
| 056 | | 56 | | | |
| 066 | | 66 | | | |
| 076 | | 76 | | | |
| 086 | | 86 | | | |
| D20_20026 | 20 | 26 | 28 | 32 | 6 |
| 036 | | 36 | | | |
| 046 | | 46 | | | |
| 056 | | 56 | | | |
| 066 | | 66 | | | |
| 076 | | 76 | | | |
| 086 | | 86 | | | |
| 096 | | 96 | | | |
| D20_25026 | 25 | 26 | 34 | 38 | 8 |
| 036 | | 36 | | | |
| 046 | | 46 | | | |
| 056 | | 56 | | | |
| 066 | | 66 | | | |
| 076 | | 76 | | | |
| 086 | | 86 | | | |
| 096 | | 96 | | | |
| 106 | | 106 | | | |

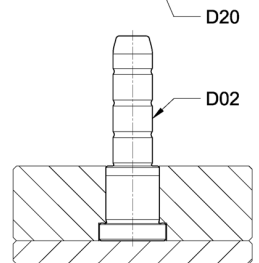
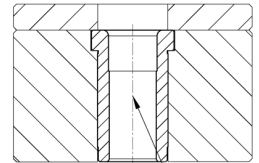
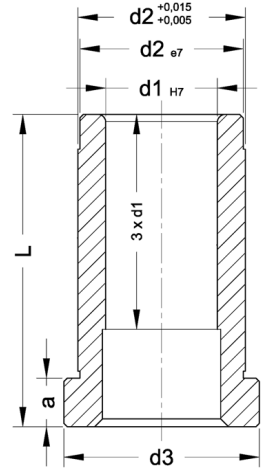

D20

Burç / Guide Bush

Malzeme - Material : Asil Çelik 1.7131 (16MnCr5)
 Sertlik - Hardness : 62± 2 HRC
 Isıl İşlem - Heat Treatment : Sementasyon (Case Hardened)



| Sipariş Kodu | Ø d1 | L | d2 | d3 | a |
|--------------|---------|-----|----|----|----|
| D20_30036 | 30 | 36 | 39 | 43 | 10 |
| 046 | | 46 | | | |
| 056 | | 56 | | | |
| 066 | | 66 | | | |
| 076 | | 76 | | | |
| 086 | | 86 | | | |
| 096 | | 96 | | | |
| 106 | | 106 | | | |
| 116 | | 116 | | | |
| D20_40046 | 40 | 46 | 54 | 58 | 10 |
| 056 | | 56 | | | |
| 066 | | 66 | | | |
| 076 | | 76 | | | |
| 086 | | 86 | | | |
| 096 | | 96 | | | |
| 106 | | 106 | | | |
| 116 | | 116 | | | |
| 126 | | 126 | | | |
| 136 | | 136 | | | |
| 146 | | 146 | | | |

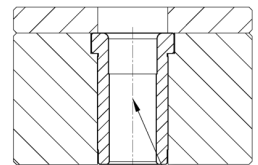
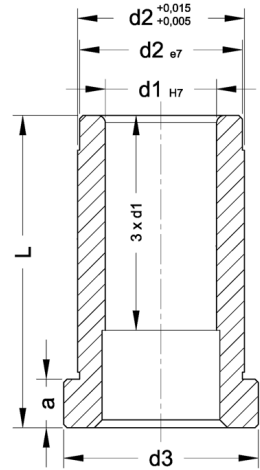

D20

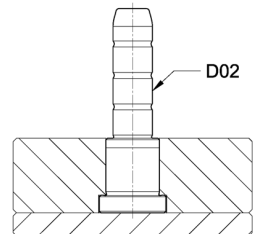

D02

D03

Kuyruklu Kolon / Tailed Guide Pillar

Malzeme - Material : Asil Çelik 1.1213 (Cf53)
 Sertlik - Hardness : 62± 2 HRC
 Isil İşlem - Heat Treatment : İndüksiyon (Induction)
 ≈DIN 16761 - A

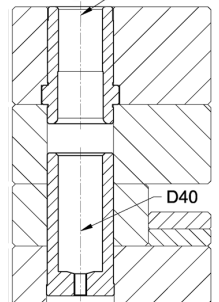
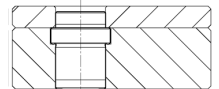
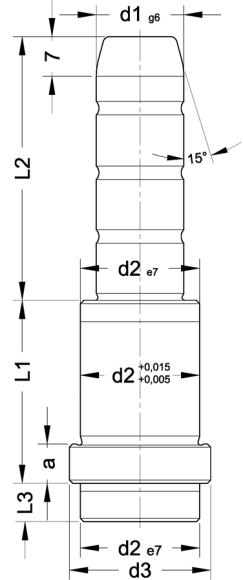

| Sipariş Kodu | d1 | Sipariş Kodu | d1 | L1 | L2 | L3 | d2 | d3 | a |
|--------------|----|--------------|----|----|-----|----|----|----|---|
| D03_14017035 | 14 | D03_15017035 | 15 | 17 | 35 | 9 | 20 | 25 | 6 |
| 055 | | 055 | | | 55 | | | | |
| 075 | | 075 | | | 75 | | | | |
| 095 | | 095 | | | 95 | | | | |
| D03_14022030 | 14 | D03_15022030 | 15 | 22 | 30 | 9 | 20 | 25 | 6 |
| 050 | | 050 | | | 50 | | | | |
| 070 | | 070 | | | 70 | | | | |
| 090 | | 090 | | | 90 | | | | |
| 110 | | 110 | | | 110 | | | | |
| 125 | | 125 | | | 125 | | | | |
| 150 | | 150 | | | 150 | | | | |
| D03_14027030 | 14 | D03_15027030 | 15 | 27 | 30 | 9 | 20 | 25 | 6 |
| 045 | | 045 | | | 45 | | | | |
| 065 | | 065 | | | 65 | | | | |
| 085 | | 085 | | | 85 | | | | |
| 105 | | 105 | | | 105 | | | | |
| 125 | | 125 | | | 125 | | | | |
| 145 | | 145 | | | 145 | | | | |
| 165 | | 165 | | | 165 | | | | |
| D03_14036035 | 14 | D03_15036035 | 15 | 36 | 35 | 9 | 20 | 25 | 6 |
| 055 | | 055 | | | 55 | | | | |
| 075 | | 075 | | | 75 | | | | |
| 095 | | 095 | | | 95 | | | | |
| 115 | | 115 | | | 115 | | | | |
| 125 | | 125 | | | 125 | | | | |
| 145 | | 145 | | | 145 | | | | |
| 155 | | 155 | | | 155 | | | | |
| D03_14046035 | 14 | D03_15046035 | 15 | 46 | 35 | 9 | 20 | 25 | 6 |
| 045 | | 045 | | | 45 | | | | |
| 065 | | 065 | | | 65 | | | | |
| 085 | | 085 | | | 85 | | | | |
| 105 | | 105 | | | 105 | | | | |
| 125 | | 125 | | | 125 | | | | |
| 145 | | 145 | | | 145 | | | | |
| D03_14056035 | 14 | D03_15056035 | 15 | 56 | 35 | 9 | 20 | 25 | 6 |
| 055 | | 055 | | | 55 | | | | |
| 075 | | 075 | | | 75 | | | | |
| 095 | | 095 | | | 95 | | | | |
| 135 | | 135 | | | 135 | | | | |
| D03_14066055 | 14 | D03_15066055 | 15 | 66 | 55 | 9 | 20 | 25 | 6 |
| 065 | | 065 | | | 65 | | | | |
| 085 | | 085 | | | 85 | | | | |

D03

Kuyruklu Kolon / Tailed Guide Pillar

Malzeme - Material : Asil Çelik 1.1213 (Cf53)
 Sertlik - Hardness : 62± 2 HRC
 Isil İşlem - Heat Treatment : İndüksiyon (Induction)
 ≈DIN 16761 - A



| Sipariş Kodu | d1 | Sipariş Kodu | d1 | L1 | L2 | L3 | d2 | d3 | a |
|--------------|----|--------------|----|-----|-----|----|----|----|---|
| D03_14066095 | 14 | D03_15066095 | 15 | 66 | 95 | 9 | 20 | 25 | 6 |
| 105 | | 105 | | | 105 | | | | |
| 125 | | 125 | | | 125 | | | | |
| D03_14076035 | 14 | D03_15076035 | 15 | 76 | 35 | 9 | 20 | 25 | 6 |
| 055 | | 055 | | | 55 | | | | |
| 075 | | 075 | | | 75 | | | | |
| 095 | | 095 | | | 95 | | | | |
| 125 | | 125 | | | 125 | | | | |
| D03_14086055 | 14 | D03_15086055 | 15 | 86 | 55 | 9 | 20 | 25 | 6 |
| 075 | | 075 | | | 75 | | | | |
| 095 | | 095 | | | 95 | | | | |
| D03_14096055 | 14 | D03_15096055 | 15 | 96 | 55 | 9 | 20 | 25 | 6 |
| 075 | | 075 | | | 75 | | | | |
| 095 | | 095 | | | 95 | | | | |
| D03_14116075 | 14 | D03_15116075 | 15 | 116 | 75 | 9 | 20 | 25 | 6 |
| D03_18017035 | 18 | D03_20017035 | 20 | 17 | 35 | 9 | 26 | 31 | 6 |
| 055 | | 055 | | | 55 | | | | |
| 075 | | 075 | | | 75 | | | | |
| 120 | | 120 | | | 120 | | | | |
| D03_18022035 | 18 | D03_20022035 | 20 | 22 | 35 | 9 | 26 | 31 | 6 |
| 045 | | 045 | | | 45 | | | | |
| 065 | | 065 | | | 65 | | | | |
| 085 | | 085 | | | 85 | | | | |
| 095 | | 095 | | | 95 | | | | |
| 115 | | 115 | | | 115 | | | | |
| D03_18027035 | 18 | D03_20027035 | 20 | 27 | 35 | 9 | 26 | 31 | 6 |
| 045 | | 045 | | | 45 | | | | |
| 065 | | 065 | | | 65 | | | | |
| 085 | | 085 | | | 85 | | | | |
| 105 | | 105 | | | 105 | | | | |
| 125 | | 125 | | | 125 | | | | |
| 165 | | 165 | | | 165 | | | | |
| 225 | | 225 | | | 225 | | | | |
| 245 | | 245 | | | 245 | | | | |
| D03_18036035 | 18 | D03_20036035 | 20 | 36 | 35 | 9 | 26 | 31 | 6 |
| 055 | | 055 | | | 55 | | | | |
| 075 | | 075 | | | 75 | | | | |
| 095 | | 095 | | | 95 | | | | |
| 115 | | 115 | | | 115 | | | | |
| 135 | | 135 | | | 135 | | | | |
| 165 | | 165 | | | 165 | | | | |
| 225 | | 225 | | | 225 | | | | |

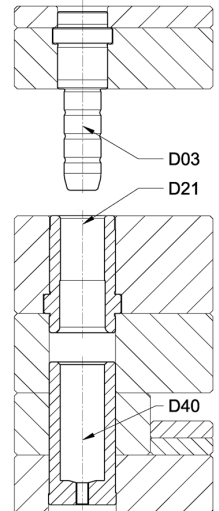
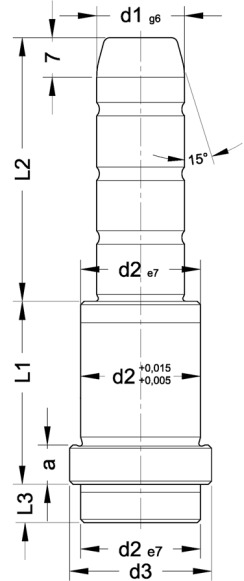

D03

Kuyruklu Kolon / Tailed Guide Pillar

Malzeme - Material : Asil Çelik 1.1213 (Cf53)
 Sertlik - Hardness : 62± 2 HRC
 Isil İşlem - Heat Treatment : İndüksiyon (Induction)
 ≈DIN 16761 - A



| Sipariş Kodu | d1 | Sipariş Kodu | d1 | L1 | L2 | L3 | d2 | d3 | a |
|--------------|----|--------------|----|-----|-----|----|----|----|---|
| D03_18036255 | 18 | D03_20036255 | 20 | 36 | 255 | 9 | 26 | 31 | 6 |
| D03_18046035 | 18 | D03_20046035 | 20 | 46 | 35 | 9 | 26 | 31 | 6 |
| 045 | | 045 | | | 45 | | | | |
| 065 | | 065 | | | 65 | | | | |
| 085 | | 085 | | | 85 | | | | |
| 105 | | 105 | | | 105 | | | | |
| 135 | | 135 | | | 135 | | | | |
| 165 | | 165 | | | 165 | | | | |
| 245 | | 245 | | | 245 | | | | |
| D03_18056035 | 18 | D03_20056035 | 20 | 56 | 35 | 9 | 26 | 31 | 6 |
| 055 | | 055 | | | 55 | | | | |
| 075 | | 075 | | | 75 | | | | |
| 095 | | 095 | | | 95 | | | | |
| 115 | | 115 | | | 115 | | | | |
| 135 | | 135 | | | 135 | | | | |
| 155 | | 155 | | | 155 | | | | |
| D03_18066035 | 18 | D03_20066035 | 20 | 66 | 35 | 9 | 26 | 31 | 6 |
| 055 | | 055 | | | 55 | | | | |
| 075 | | 075 | | | 75 | | | | |
| 095 | | 095 | | | 95 | | | | |
| 115 | | 115 | | | 115 | | | | |
| 135 | | 135 | | | 135 | | | | |
| 145 | | 145 | | | 145 | | | | |
| D03_18076035 | 18 | D03_20076035 | 20 | 76 | 35 | 9 | 26 | 31 | 6 |
| 055 | | 055 | | | 55 | | | | |
| 075 | | 075 | | | 75 | | | | |
| 095 | | 095 | | | 95 | | | | |
| 115 | | 115 | | | 115 | | | | |
| 135 | | 135 | | | 135 | | | | |
| D03_18086055 | 18 | D03_20086055 | 20 | 86 | 55 | 9 | 26 | 31 | 6 |
| 075 | | 075 | | | 75 | | | | |
| 095 | | 095 | | | 95 | | | | |
| 125 | | 125 | | | 125 | | | | |
| 135 | | 135 | | | 135 | | | | |
| D03_18096055 | 18 | D03_20096055 | 20 | 96 | 55 | 9 | 26 | 31 | 6 |
| 075 | | 075 | | | 75 | | | | |
| 095 | | 095 | | | 95 | | | | |
| D03_18116075 | 18 | D03_20116075 | 20 | 116 | 75 | 9 | 26 | 31 | 6 |
| 115 | | 115 | | | 115 | | | | |
| D03_18136135 | 18 | D03_20136135 | 20 | 136 | 135 | 9 | 26 | 31 | 6 |
| D03_22017035 | 22 | D03_24017035 | 24 | 17 | 35 | 9 | 30 | 35 | 6 |
| 055 | | 055 | | | 55 | | | | |

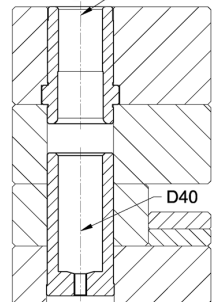
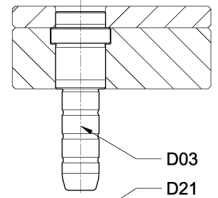
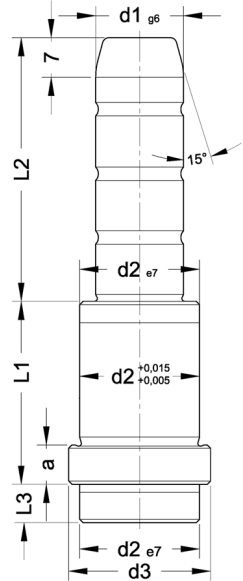

D03

Kuyruklu Kolon / Tailed Guide Pillar

Malzeme - Material : Asil Çelik 1.1213 (Cf53)
 Sertlik - Hardness : 62± 2 HRC
 Isil İşlem - Heat Treatment : İndüksiyon (Induction)
 ≈DIN 16761 - A



| Sipariş Kodu | d1 | Sipariş Kodu | d1 | L1 | L2 | L3 | d2 | d3 | a |
|--------------|----|--------------|----|----|-----|----|----|----|---|
| D03_22017075 | 22 | D03_24017075 | 24 | 17 | 75 | 9 | 30 | 35 | 6 |
| D03_22022035 | 22 | D03_24022035 | 24 | 22 | 35 | 9 | 30 | 35 | 6 |
| 055 | | 055 | | | 55 | | | | |
| 075 | | 075 | | | 75 | | | | |
| 095 | | 095 | | | 95 | | | | |
| 105 | | 105 | | | 105 | | | | |
| 130 | | 130 | | | 130 | | | | |
| D03_22027035 | 22 | D03_24027035 | 24 | 27 | 35 | 9 | 30 | 35 | 6 |
| 045 | | 045 | | | 45 | | | | |
| 065 | | 065 | | | 65 | | | | |
| 085 | | 085 | | | 85 | | | | |
| 105 | | 105 | | | 105 | | | | |
| 125 | | 125 | | | 125 | | | | |
| 165 | | 165 | | | 165 | | | | |
| 205 | | 205 | | | 205 | | | | |
| 245 | | 245 | | | 245 | | | | |
| D03_22036035 | 22 | D03_24036035 | 24 | 36 | 35 | 9 | 30 | 35 | 6 |
| 055 | | 055 | | | 55 | | | | |
| 075 | | 075 | | | 75 | | | | |
| 095 | | 095 | | | 95 | | | | |
| 115 | | 115 | | | 115 | | | | |
| 135 | | 135 | | | 135 | | | | |
| 165 | | 165 | | | 165 | | | | |
| 205 | | 205 | | | 205 | | | | |
| 245 | | 245 | | | 245 | | | | |
| 285 | | 285 | | | 285 | | | | |
| D03_22046035 | 22 | D03_24046035 | 24 | 46 | 35 | 9 | 30 | 35 | 6 |
| 045 | | 045 | | | 45 | | | | |
| 065 | | 065 | | | 65 | | | | |
| 085 | | 085 | | | 85 | | | | |
| 105 | | 105 | | | 105 | | | | |
| 125 | | 125 | | | 125 | | | | |
| 165 | | 165 | | | 165 | | | | |
| 205 | | 205 | | | 205 | | | | |
| D03_22056035 | 22 | D03_24056035 | 24 | 56 | 35 | 9 | 30 | 35 | 6 |
| 055 | | 055 | | | 55 | | | | |
| 075 | | 075 | | | 75 | | | | |
| 095 | | 095 | | | 95 | | | | |
| 115 | | 115 | | | 115 | | | | |
| 135 | | 135 | | | 135 | | | | |
| 165 | | 165 | | | 165 | | | | |
| 205 | | 205 | | | 205 | | | | |

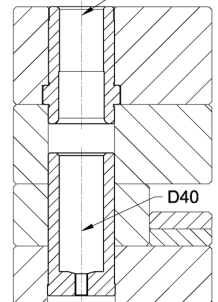
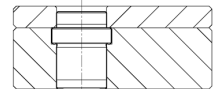
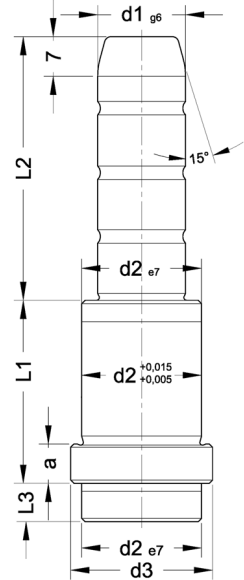

D03

Kuyruklu Kolon / Tailed Guide Pillar

Malzeme - Material : Asil Çelik 1.1213 (Cf53)
 Sertlik - Hardness : 62± 2 HRC
 Isil İşlem - Heat Treatment : İndüksiyon (Induction)
 ≈DIN 16761 - A



| Sipariş Kodu | d1 | Sipariş Kodu | d1 | L1 | L2 | L3 | d2 | d3 | a |
|--------------|----|--------------|----|-----|-----|----|----|----|---|
| D03_22066035 | 22 | D03_24066035 | 24 | 66 | 35 | 9 | 30 | 35 | 6 |
| 055 | | 055 | | | 55 | | | | |
| 075 | | 075 | | | 75 | | | | |
| 095 | | 095 | | | 95 | | | | |
| 115 | | 115 | | | 115 | | | | |
| 135 | | 135 | | | 135 | | | | |
| 155 | | 155 | | | 155 | | | | |
| D03_22076035 | 22 | D03_24076035 | 24 | 76 | 35 | 9 | 30 | 35 | 6 |
| 055 | | 055 | | | 55 | | | | |
| 075 | | 075 | | | 75 | | | | |
| 095 | | 095 | | | 95 | | | | |
| 115 | | 115 | | | 115 | | | | |
| 145 | | 145 | | | 145 | | | | |
| D03_22086055 | 22 | D03_24086055 | 24 | 86 | 55 | 9 | 30 | 35 | 6 |
| 075 | | 075 | | | 75 | | | | |
| 095 | | 095 | | | 95 | | | | |
| 125 | | 125 | | | 125 | | | | |
| 135 | | 135 | | | 135 | | | | |
| D03_22096055 | 22 | D03_24096055 | 24 | 96 | 55 | 9 | 30 | 35 | 6 |
| 075 | | 075 | | | 75 | | | | |
| 095 | | 095 | | | 95 | | | | |
| 125 | | 125 | | | 125 | | | | |
| D03_22106055 | 22 | D03_24106055 | 24 | 106 | 55 | 9 | 30 | 35 | 6 |
| 075 | | 075 | | | 75 | | | | |
| 095 | | 095 | | | 95 | | | | |
| 115 | | 115 | | | 115 | | | | |
| D03_22116075 | 22 | D03_24116075 | 24 | 116 | 75 | 9 | 30 | 35 | 6 |
| 115 | | 115 | | | 115 | | | | |
| 155 | | 155 | | | 155 | | | | |
| D03_22136095 | 22 | D03_24136095 | 24 | 136 | 95 | 9 | 30 | 35 | 6 |
| 135 | | 135 | | | 135 | | | | |
| D03_30027035 | 30 | D03_32027035 | 32 | 27 | 35 | 9 | 42 | 47 | 6 |
| 045 | | 045 | | | 45 | | | | |
| 065 | | 065 | | | 65 | | | | |
| 085 | | 085 | | | 85 | | | | |
| 105 | | 105 | | | 105 | | | | |
| 125 | | 125 | | | 125 | | | | |
| 145 | | 145 | | | 145 | | | | |
| 165 | | 165 | | | 165 | | | | |
| 185 | | 185 | | | 185 | | | | |
| 245 | | 245 | | | 245 | | | | |
| 285 | | 285 | | | 285 | | | | |

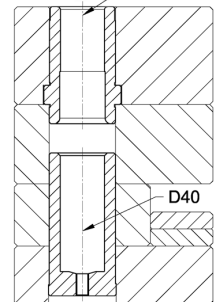
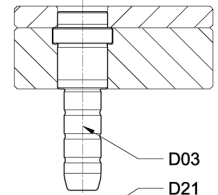
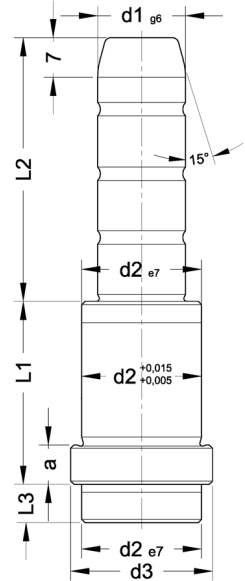

D03

Kuyruklu Kolon / Tailed Guide Pillar

Malzeme - Material : Asil Çelik 1.1213 (Cf53)
 Sertlik - Hardness : 62± 2 HRC
 Isil İşlem - Heat Treatment : İndüksiyon (Induction)
 ≈DIN 16761 - A



| Sipariş Kodu | d1 | Sipariş Kodu | d1 | L1 | L2 | L3 | d2 | d3 | a |
|--------------|----|--------------|----|----|-----|----|----|----|---|
| D03_30036035 | 30 | D03_32036035 | 32 | 36 | 35 | 9 | 42 | 47 | 6 |
| 055 | | 055 | | | 55 | | | | |
| 075 | | 075 | | | 75 | | | | |
| 095 | | 095 | | | 95 | | | | |
| 115 | | 115 | | | 115 | | | | |
| 135 | | 135 | | | 135 | | | | |
| 155 | | 155 | | | 155 | | | | |
| 245 | | 245 | | | 245 | | | | |
| 285 | | 285 | | | 285 | | | | |
| D03_30046045 | 30 | D03_32046045 | 32 | 46 | 45 | 9 | 42 | 47 | 6 |
| 065 | | 065 | | | 65 | | | | |
| 085 | | 085 | | | 85 | | | | |
| 105 | | 105 | | | 105 | | | | |
| 125 | | 125 | | | 125 | | | | |
| 145 | | 145 | | | 145 | | | | |
| 165 | | 165 | | | 165 | | | | |
| 245 | | 245 | | | 245 | | | | |
| 285 | | 285 | | | 285 | | | | |
| D03_30056045 | 30 | D03_32056045 | 32 | 56 | 45 | 9 | 42 | 47 | 6 |
| 055 | | 055 | | | 55 | | | | |
| 075 | | 075 | | | 75 | | | | |
| 095 | | 095 | | | 95 | | | | |
| 115 | | 115 | | | 115 | | | | |
| 135 | | 135 | | | 135 | | | | |
| 155 | | 155 | | | 155 | | | | |
| 175 | | 175 | | | 175 | | | | |
| 245 | | 245 | | | 245 | | | | |
| 295 | | 295 | | | 295 | | | | |
| D03_30066045 | 30 | D03_32066045 | 32 | 66 | 45 | 9 | 42 | 47 | 6 |
| 055 | | 055 | | | 55 | | | | |
| 075 | | 075 | | | 75 | | | | |
| 095 | | 095 | | | 95 | | | | |
| 115 | | 115 | | | 115 | | | | |
| 135 | | 135 | | | 135 | | | | |
| 155 | | 155 | | | 155 | | | | |
| 175 | | 175 | | | 175 | | | | |
| 245 | | 245 | | | 245 | | | | |
| 295 | | 295 | | | 295 | | | | |
| D03_30076055 | 30 | D03_32076055 | 32 | 76 | 55 | 9 | 42 | 47 | 6 |
| 075 | | 075 | | | 75 | | | | |
| 095 | | 095 | | | 95 | | | | |
| 115 | | 115 | | | 115 | | | | |

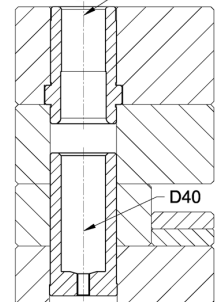
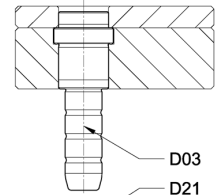
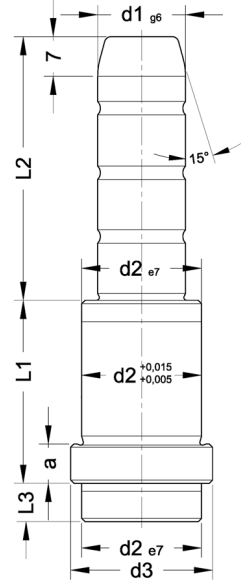

D03

Kuyruklu Kolon / Tailed Guide Pillar

Malzeme - Material : Asil Çelik 1.1213 (Cf53)
 Sertlik - Hardness : 62± 2 HRC
 Isil İşlem - Heat Treatment : İndüksiyon (Induction)
 ≈DIN 16761 - A



| Sipariş Kodu | d1 | Sipariş Kodu | d1 | L1 | L2 | L3 | d2 | d3 | a |
|--------------|----|--------------|----|-----|-----|----|----|----|----|
| D03_30076135 | 30 | D03_32076135 | 32 | 76 | 135 | 9 | 42 | 47 | 6 |
| 155 | | 155 | | | 155 | | | | |
| 225 | | 225 | | | 225 | | | | |
| D03_30086055 | 30 | D03_32086055 | 32 | 86 | 55 | 9 | 42 | 47 | 6 |
| 075 | | 075 | | | 75 | | | | |
| 095 | | 095 | | | 95 | | | | |
| 115 | | 115 | | | 115 | | | | |
| 135 | | 135 | | | 135 | | | | |
| 155 | | 155 | | | 155 | | | | |
| 225 | | 225 | | | 225 | | | | |
| D03_30096055 | 30 | D03_32096055 | 32 | 96 | 55 | 9 | 42 | 47 | 6 |
| 075 | | 075 | | | 75 | | | | |
| 095 | | 095 | | | 95 | | | | |
| 115 | | 115 | | | 115 | | | | |
| 135 | | 135 | | | 135 | | | | |
| 155 | | 155 | | | 155 | | | | |
| 205 | | 205 | | | 205 | | | | |
| D03_30106075 | 30 | D03_32106075 | 32 | 106 | 75 | 9 | 42 | 47 | 6 |
| 095 | | 095 | | | 95 | | | | |
| 115 | | 115 | | | 115 | | | | |
| 125 | | 125 | | | 125 | | | | |
| 145 | | 145 | | | 145 | | | | |
| 165 | | 165 | | | 165 | | | | |
| D03_30116075 | 30 | D03_32116075 | 32 | 116 | 75 | 9 | 42 | 47 | 6 |
| 095 | | 095 | | | 95 | | | | |
| 115 | | 115 | | | 115 | | | | |
| 135 | | 135 | | | 135 | | | | |
| 155 | | 155 | | | 155 | | | | |
| D03_30136095 | 30 | D03_32136095 | 32 | 136 | 95 | 9 | 42 | 47 | 6 |
| 115 | | 115 | | | 115 | | | | |
| 135 | | 135 | | | 135 | | | | |
| 155 | | 155 | | | 155 | | | | |
| D03_30156115 | 30 | D03_32156115 | 32 | 156 | 115 | 9 | 42 | 47 | 6 |
| 155 | | 155 | | | 155 | | | | |
| D03_30196155 | 30 | D03_32196155 | 32 | 196 | 155 | 9 | 42 | 47 | 6 |
| 195 | | 195 | | | 195 | | | | |
| D03_40046095 | 40 | D03_42046095 | 42 | 46 | 95 | 12 | 54 | 60 | 10 |
| 165 | | 165 | | | 165 | | | | |
| D03_40056075 | 40 | D03_42056075 | 42 | 56 | 75 | 12 | 54 | 60 | 10 |
| 115 | | 115 | | | 115 | | | | |
| 155 | | 155 | | | 155 | | | | |
| 195 | | 195 | | | 195 | | | | |

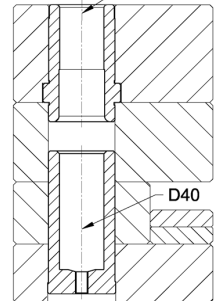
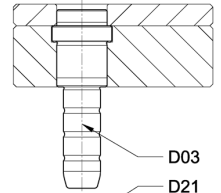
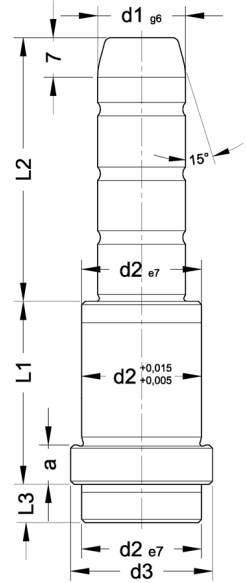

D03

Kuyruklu Kolon / Tailed Guide Pillar

Malzeme - Material : Asil Çelik 1.1213 (Cf53)
 Sertlik - Hardness : 62± 2 HRC
 Isil İşlem - Heat Treatment : İndüksiyon (Induction)
 ≈DIN 16761 - A



| Sipariş Kodu | d1 | Sipariş Kodu | d1 | L1 | L2 | L3 | d2 | d3 | a |
|--------------|----|--------------|----|-----|-----|----|----|----|----|
| D03_40066075 | 40 | D03_42066075 | 42 | 66 | 75 | 12 | 54 | 60 | 10 |
| 135 | | 135 | | | 135 | | | | |
| D03_40076075 | 40 | D03_42076075 | 42 | 76 | 75 | 12 | 54 | 60 | 10 |
| 115 | | 115 | | | 115 | | | | |
| 175 | | 175 | | | 175 | | | | |
| D03_40086075 | 40 | D03_42086075 | 42 | 86 | 75 | 12 | 54 | 60 | 10 |
| 135 | | 135 | | | 135 | | | | |
| D03_40096075 | 40 | D03_42096075 | 42 | 96 | 75 | 12 | 54 | 60 | 10 |
| 115 | | 115 | | | 115 | | | | |
| 155 | | 155 | | | 155 | | | | |
| D03_40116095 | 40 | D03_42116095 | 42 | 116 | 95 | 12 | 54 | 60 | 10 |
| 135 | | 135 | | | 135 | | | | |
| 195 | | 195 | | | 195 | | | | |
| D03_40136095 | 40 | D03_42136095 | 42 | 136 | 95 | 12 | 54 | 60 | 10 |
| 135 | | 135 | | | 135 | | | | |
| 215 | | 215 | | | 215 | | | | |
| D03_40156115 | 40 | D03_42156115 | 42 | 156 | 115 | 12 | 54 | 60 | 10 |
| 155 | | 155 | | | 155 | | | | |
| 215 | | 215 | | | 215 | | | | |
| D03_40196155 | 40 | D03_42196155 | 42 | 196 | 155 | 12 | 54 | 60 | 10 |
| 195 | | 195 | | | 195 | | | | |
| 235 | | 235 | | | 235 | | | | |
| D03_40246165 | 40 | D03_42246165 | 42 | 246 | 165 | 12 | 54 | 60 | 10 |
| 245 | | 245 | | | 245 | | | | |

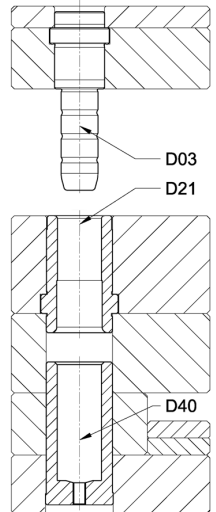
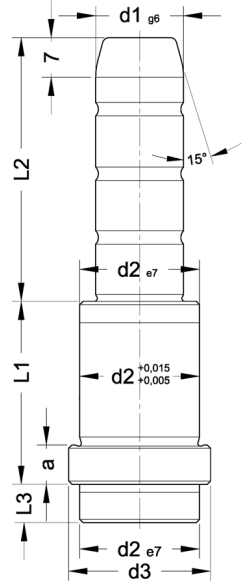

D21

Kuyruklu Burç / Tailed Guide Bush

Malzeme - Material : Asil Çelik 1.7131 (16MnCr5)
 Sertlik - Hardness : 62± 2 HRC
 Isil İşlem - Heat Treatment : Sementasyon (Case Hardened)
 ≈DIN 16716 - C



| Sipariş Kodu | d1 | Sipariş Kodu | d1 | L | d2 | d3 | a | L1 |
|--------------|----|--------------|----|-----|----|----|---|----|
| D21_14017 | 14 | D21_15017 | 15 | 17 | 20 | 25 | 6 | 9 |
| 022 | | 022 | | 22 | | | | |
| 027 | | 027 | | 27 | | | | |
| 036 | | 036 | | 36 | | | | |
| 046 | | 046 | | 46 | | | | |
| 056 | | 056 | | 56 | | | | |
| 066 | | 066 | | 66 | | | | |
| 076 | | 076 | | 76 | | | | |
| 086 | | 086 | | 86 | | | | |
| 096 | | 096 | | 96 | | | | |
| 116 | | 116 | | 116 | | | | |
| D21_18017 | 18 | D21_20017 | 20 | 17 | 26 | 31 | 6 | 9 |
| 022 | | 022 | | 22 | | | | |
| 027 | | 027 | | 27 | | | | |
| 036 | | 036 | | 36 | | | | |
| 046 | | 046 | | 46 | | | | |
| 056 | | 056 | | 56 | | | | |
| 066 | | 066 | | 66 | | | | |
| 076 | | 076 | | 76 | | | | |
| 086 | | 086 | | 86 | | | | |
| 096 | | 096 | | 96 | | | | |
| 106 | | 106 | | 106 | | | | |
| 116 | | 116 | | 116 | | | | |
| 136 | | 136 | | 136 | | | | |
| D21_22017 | 22 | D21_24017 | 24 | 17 | 30 | 35 | 6 | 9 |
| 022 | | 022 | | 22 | | | | |
| 027 | | 027 | | 27 | | | | |
| 036 | | 036 | | 36 | | | | |
| 046 | | 046 | | 46 | | | | |
| 056 | | 056 | | 56 | | | | |
| 066 | | 066 | | 66 | | | | |
| 076 | | 076 | | 76 | | | | |
| 086 | | 086 | | 86 | | | | |
| 096 | | 096 | | 96 | | | | |
| 106 | | 106 | | 106 | | | | |
| 116 | | 116 | | 116 | | | | |
| 136 | | 136 | | 136 | | | | |
| 156 | | 156 | | 156 | | | | |
| D21_30027 | 30 | D21_32027 | 32 | 27 | 42 | 47 | 6 | 9 |
| 036 | | 036 | | 36 | | | | |
| 046 | | 046 | | 46 | | | | |
| 056 | | 056 | | 56 | | | | |

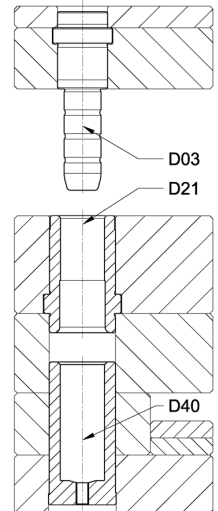
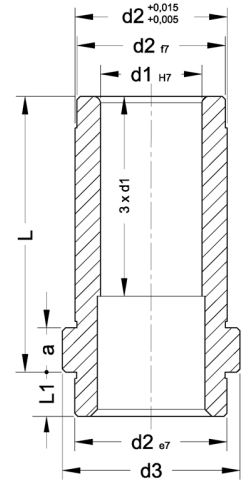

D21

Kuyruklu Burç / Tailed Guide Bush

Malzeme - Material : Asil Çelik 1.7131 (16MnCr5)
 Sertlik - Hardness : 62 ± 2 HRC
 Isil İşlem - Heat Treatment : Sementasyon (Case Hardened)
 ≈DIN 16716 - C



| Sipariş Kodu | d1 | Sipariş Kodu | d1 | L | d2 | d3 | a | L1 |
|--------------|----|--------------|----|-----|----|----|----|----|
| D21_30066 | 30 | D21_32066 | 32 | 66 | 42 | 47 | 6 | 9 |
| 076 | | 076 | | 76 | | | | |
| 086 | | 086 | | 86 | | | | |
| 096 | | 096 | | 96 | | | | |
| 106 | | 106 | | 106 | | | | |
| 116 | | 116 | | 116 | | | | |
| 126 | | 126 | | 126 | | | | |
| 136 | | 136 | | 136 | | | | |
| 156 | | 156 | | 156 | | | | |
| 196 | | 196 | | 196 | | | | |
| D21_40046 | 40 | D21_42046 | 42 | 46 | 54 | 60 | 10 | 12 |
| 056 | | 056 | | 56 | | | | |
| 066 | | 066 | | 66 | | | | |
| 076 | | 076 | | 76 | | | | |
| 086 | | 086 | | 86 | | | | |
| 096 | | 096 | | 96 | | | | |
| 116 | | 116 | | 116 | | | | |
| 136 | | 136 | | 136 | | | | |
| 156 | | 156 | | 156 | | | | |
| 196 | | 196 | | 196 | | | | |
| 246 | | 246 | | 246 | | | | |

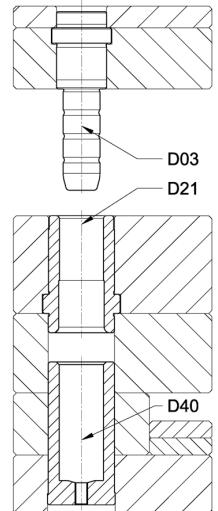
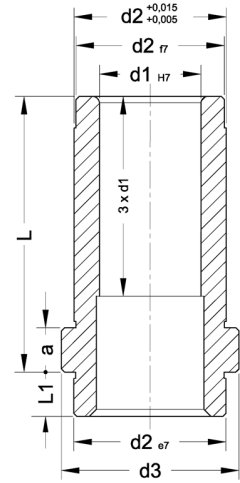

D40

Tespit Burcu / Centring Sleeves

Malzeme - Material : Asil Çelik 1.7131 (16MnCr5)
 Sertlik - Hardness : 62± 2 HRC
 Isil İşlem - Heat Treatment : Sementasyon (Case Hardened)
 ≈DIN 16759



| Ø | | | | | | | |
|--------------|----|-----|----|----|----|-----|---------|
| Sipariş Kodu | d2 | L | d1 | M | L1 | L2 | d2 Tol. |
| D40_20030 | 20 | 30 | 16 | 12 | 10 | 2 | g6 |
| 040 | | 40 | | | | | |
| 060 | | 60 | | | | | |
| 080 | | 80 | | | | | |
| 100 | | 100 | | | | | |
| 120 | | 120 | | | | | |
| 140 | | 140 | | | | | |
| 160 | | 160 | | | | | |
| D40_26030 | 26 | 30 | 21 | 12 | 13 | 2.5 | g6 |
| 040 | | 40 | | | | | |
| 060 | | 60 | | | | | |
| 080 | | 80 | | | | | |
| 100 | | 100 | | | | | |
| 120 | | 120 | | | | | |
| 140 | | 140 | | | | | |
| 160 | | 160 | | | | | |
| 180 | | 180 | | | | | |
| D40_30040 | 30 | 40 | 25 | 12 | 13 | 2.5 | g6 |
| 060 | | 60 | | | | | |
| 080 | | 80 | | | | | |
| 100 | | 100 | | | | | |
| 120 | | 120 | | | | | |
| 140 | | 140 | | | | | |
| 160 | | 160 | | | | | |
| 180 | | 180 | | | | | |
| 200 | | 200 | | | | | |
| 240 | | 240 | | | | | |
| D40_42040 | 42 | 40 | 33 | 12 | 16 | 4.5 | g6 |
| 060 | | 60 | | | | | |
| 080 | | 80 | | | | | |
| 100 | | 100 | | | | | |
| 120 | | 120 | | | | | |
| 140 | | 140 | | | | | |
| 160 | | 160 | | | | | |
| 180 | | 180 | | | | | |
| 200 | | 200 | | | | | |
| 220 | | 220 | | | | | |
| 260 | | 260 | | | | | |
| 300 | | 300 | | | | | |
| D40_54060 | 54 | 60 | 43 | 12 | 16 | 4.5 | f6 |
| 080 | | 80 | | | | | |
| 120 | | 120 | | | | | |

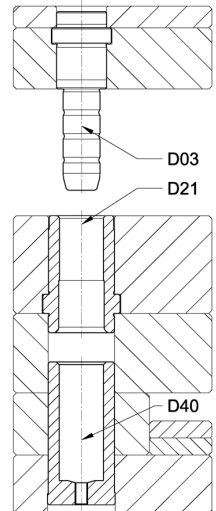
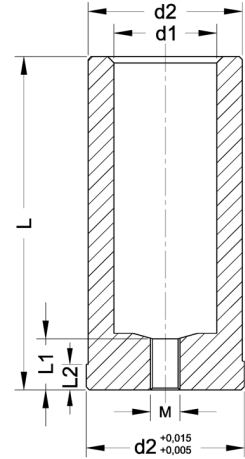

D40

Tespit Burcu / Centring Sleeves

Malzeme - Material : Asil Çelik 1.7131 (16MnCr5)
 Sertlik - Hardness : 62 ± 2 HRC
 Isıl İşlem - Heat Treatment : Sementasyon (Case Hardened)
 ≈DIN 16759



| Sipariş Kodu | d2 | L | d1 | M | L1 | L2 | d2 Tol. |
|--------------|----|-----|----|----|----|-----|---------|
| D40_54160 | 54 | 160 | 43 | 12 | 16 | 4.5 | f6 |
| 200 | | 200 | | | | | |
| 240 | | 240 | | | | | |
| 280 | | 280 | | | | | |

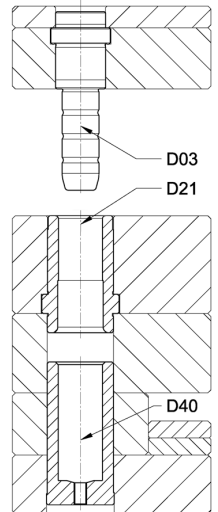
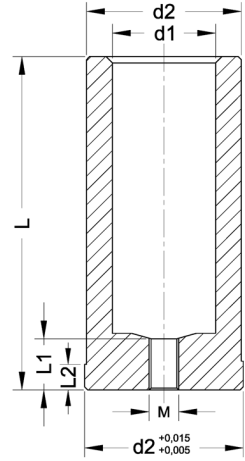

D01

Kolon / Guide Pillar

Malzeme - Material : Asil Çelik 1.1213 (Cf 53)
 Sertlik - Hardness : 62± 2 HRC
 Isil İşlem - Heat Treatment : İndüksiyon (Induction)

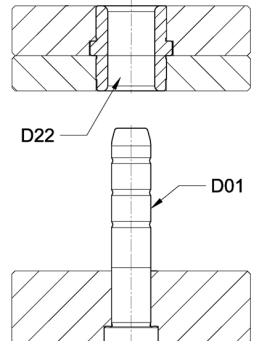
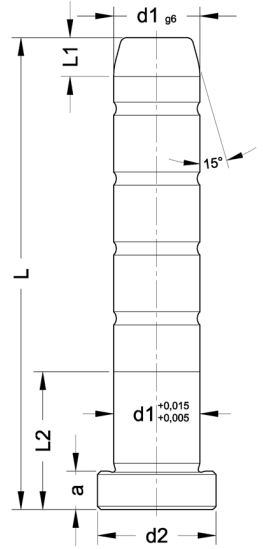

| Ø | | | | | | |
|--------------|-----|-----|----|----|----|---|
| Sipariş Kodu | d1 | L | L1 | L2 | d2 | a |
| D01_10040 | 10 | 40 | 4 | 17 | 12 | 3 |
| 060 | | 60 | | 22 | | |
| 080 | | 80 | | | | |
| 100 | | 100 | | | | |
| 120 | | 120 | | | | |
| D01_12040 | 12 | 40 | 7 | 17 | 16 | 6 |
| 060 | | 60 | | 22 | | |
| 080 | | 80 | | | | |
| 100 | | 100 | | | | |
| 120 | | 120 | | | | |
| 140 | | 140 | | | | |
| 160 | | 160 | | | | |
| D01_14060 | 14 | 60 | 7 | 17 | 18 | 8 |
| 080 | | 80 | | 22 | | |
| 100 | | 100 | | | | |
| 120 | | 120 | | | | |
| 140 | | 140 | | | | |
| 160 | | 160 | | | | |
| 180 | | 180 | | | | |
| 200 | | 200 | | | | |
| D01_16040 | 16 | 40 | 7 | 22 | 20 | 8 |
| 060 | | 60 | | 27 | | |
| 080 | | 80 | | | | |
| 100 | | 100 | | | | |
| 120 | | 120 | | | | |
| 140 | | 140 | | | | |
| 160 | | 160 | | | | |
| 180 | | 180 | | 46 | | |
| 200 | | 200 | | | | |
| D01_18060 | | 18 | | 60 | | |
| 080 | 80 | | 36 | | | |
| 100 | 100 | | | | | |
| 120 | 120 | | | | | |
| 140 | 140 | | | 46 | | |
| 160 | 160 | | | | | |
| 180 | 180 | | | | | |
| 200 | 200 | | | | | |
| 240 | 240 | 56 | | | | |
| D01_20060 | 20 | 60 | 7 | 27 | 24 | 8 |
| 080 | | 80 | | 36 | | |
| 100 | | 100 | | | | |
| 120 | | 120 | | | | |
| 140 | | 140 | | | | |

D01

Kolon / Guide Pillar

Malzeme - Material : Asil Çelik 1.1213 (Cf 53)
 Sertlik - Hardness : 62± 2 HRC
 Isıl İşlem - Heat Treatment : İndüksiyon (Induction)



| Sipariş Kodu | Ø | L | L1 | L2 | d2 | a |
|--------------|----|-----|----|----|----|----|
| D01_20160 | 20 | 160 | 7 | 46 | 24 | 8 |
| 180 | | 180 | | | | |
| 200 | | 200 | | 56 | | |
| 240 | | 240 | | 76 | | |
| D01_22080 | 22 | 80 | 7 | 36 | 26 | 15 |
| 100 | | 100 | | | | |
| 120 | | 120 | | | | |
| 140 | | 140 | | | | |
| 160 | | 160 | | 46 | | |
| 180 | | 180 | | 56 | | |
| 200 | | 200 | | | | |
| 220 | | 220 | | | | |
| 240 | | 240 | | 66 | | |
| 300 | | 300 | | | | |
| D01_24080 | 24 | 80 | 7 | 36 | 28 | 15 |
| 100 | | 100 | | | | |
| 120 | | 120 | | | | |
| 140 | | 140 | | | | |
| 160 | | 160 | | 46 | | |
| 180 | | 180 | | 56 | | |
| 200 | | 200 | | | | |
| 220 | | 220 | | | | |
| 240 | | 240 | | 66 | | |
| 300 | | 300 | | | | |
| D01_25100 | 25 | 100 | 7 | 35 | 29 | 10 |
| 120 | | 120 | | | | |
| 140 | | 140 | | | | |
| 160 | | 160 | | | | |
| 180 | | 180 | | | | |
| 200 | | 200 | | | | |
| 220 | | 220 | | | | |
| 250 | | 250 | | | | |
| D01_30100 | 30 | 100 | 7 | 36 | 36 | 15 |
| 120 | | 120 | | | | |
| 140 | | 140 | | | | |
| 160 | | 160 | | 46 | | |
| 180 | | 180 | | 56 | | |
| 200 | | 200 | | 66 | | |
| 220 | | 220 | | | | |
| 240 | | 240 | | | | |
| 300 | | 300 | | 76 | | |
| 360 | | 360 | | | | |

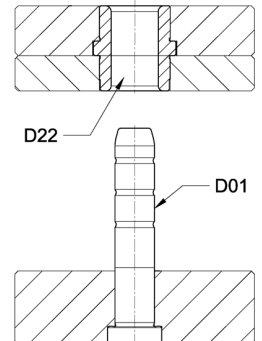
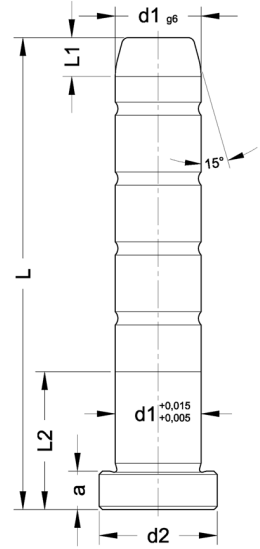

D01

Kolon / Guide Pillar

Malzeme - Material : Asil Çelik 1.1213 (Cf 53)
 Sertlik - Hardness : 62± 2 HRC
 Isil İşlem - Heat Treatment : İndüksiyon (Induction)



| Sipariş Kodu | Ø | L | L1 | L2 | d2 | a |
|--------------|-----|-----|----|-----|----|----|
| D01_40160 | 40 | 160 | 10 | 46 | 48 | 15 |
| 180 | | 180 | | 56 | | |
| 200 | | 200 | | 66 | | |
| 220 | | 220 | | | | |
| 240 | | 240 | | | | |
| 280 | | 280 | | | | |
| 300 | | 300 | | 76 | | |
| 320 | | 320 | | | | |
| 360 | | 360 | | | | |
| D01_50160 | | 50 | | 160 | | |
| 200 | 200 | | | | | |
| 240 | 240 | | | | | |
| 300 | 300 | | 66 | | | |
| 360 | 360 | | 76 | | | |

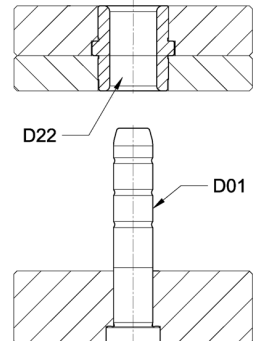
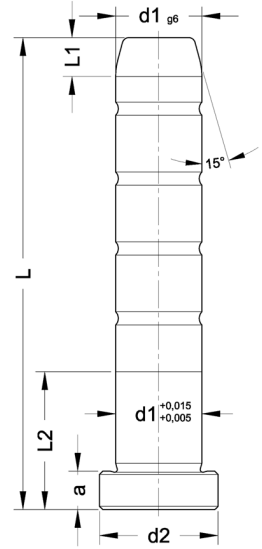

D22

Flanşlı Burç / Middle Flanged Bush

Malzeme - Material : Asil Çelik 1.7131 (16MnCr5)
 Sertlik - Hardness : 62 ± 2 HRC
 Isıl İşlem - Heat Treatment : Sementasyon (Case Hardened)



| Sipariş Kodu | $d1$ | $L1$ | $d2$ | $d3$ | $L2$ |
|--------------|------|------|------|------|------|
| D22_1216 | 12 | 16 | 16 | 19 | 12 |
| D22_1416 | 14 | 16 | 20 | 25 | 12 |
| D22_1616 | 16 | 16 | 24 | 28 | 12 |
| D22_1816 | 18 | 16 | 26 | 31 | 12 |
| D22_2016 | 20 | 16 | 28 | 32 | 12 |
| D22_2421 | 24 | 21 | 34 | 38 | 16 |
| D22_2521 | 25 | 21 | 34 | 38 | 16 |
| D22_3021 | 30 | 21 | 39 | 43 | 16 |

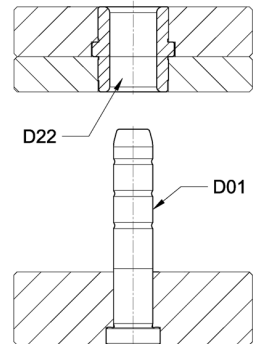
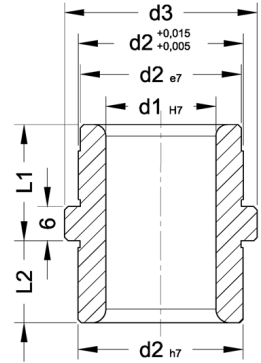

D01D

Kolon / Guide Pillar

Malzeme - Material : Asil Çelik 1.1213 (Cf 53)
 Sertlik - Hardness : 62± 2 HRC
 Isıl İşlem - Heat Treatment : İndüksiyon (Induction)
 DIN ISO 8404 - A

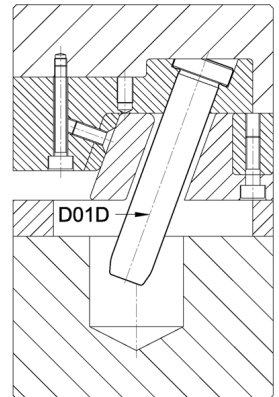
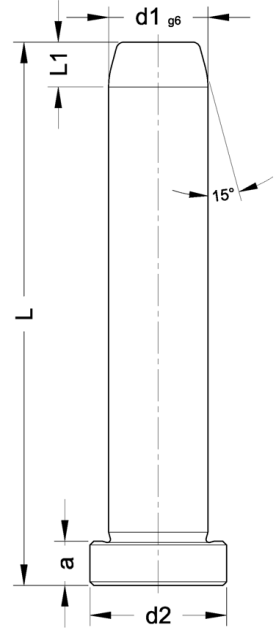

| Sipariş Kodu | Ø d1 | L | L1 | d2 | a |
|--------------|---------|-----|----|----|---|
| D01D_10040 | 10 | 40 | 4 | 12 | 3 |
| 060 | | 60 | | | |
| 080 | | 80 | | | |
| 100 | | 100 | | | |
| 120 | | 120 | | | |
| D01D_12040 | | 12 | | | |
| 060 | 60 | | | | |
| 080 | 80 | | | | |
| 100 | 100 | | | | |
| 120 | 120 | | | | |
| 140 | 140 | | | | |
| 160 | 160 | | | | |
| D01D_14060 | 14 | 60 | 7 | 18 | 8 |
| 080 | | 80 | | | |
| 100 | | 100 | | | |
| 120 | | 120 | | | |
| 140 | | 140 | | | |
| 160 | | 160 | | | |
| 180 | | 180 | | | |
| D01D_16040 | 16 | 40 | 7 | 20 | 8 |
| 060 | | 60 | | | |
| 080 | | 80 | | | |
| 100 | | 100 | | | |
| 120 | | 120 | | | |
| 140 | | 140 | | | |
| 160 | | 160 | | | |
| 180 | | 180 | | | |
| 200 | | 200 | | | |
| D01D_18060 | | 18 | | | |
| 080 | 80 | | | | |
| 100 | 100 | | | | |
| 120 | 120 | | | | |
| 140 | 140 | | | | |
| 160 | 160 | | | | |
| 180 | 180 | | | | |
| 200 | 200 | | | | |
| D01D_20060 | 20 | 60 | 7 | 24 | 8 |
| 080 | | 80 | | | |
| 100 | | 100 | | | |
| 120 | | 120 | | | |
| 140 | | 140 | | | |
| 140 | | 140 | | | |

D01D

Kolon / Guide Pillar

Malzeme - Material : Asil Çelik 1.1213 (Cf 53)
 Sertlik - Hardness : 62± 2 HRC
 Isil İşlem - Heat Treatment : İndüksiyon (Induction)
 DIN ISO 8404 - A

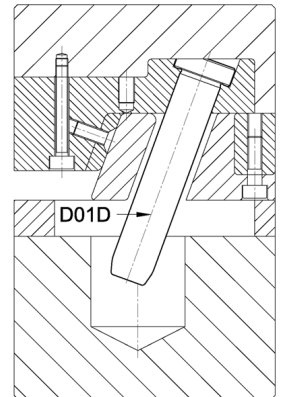
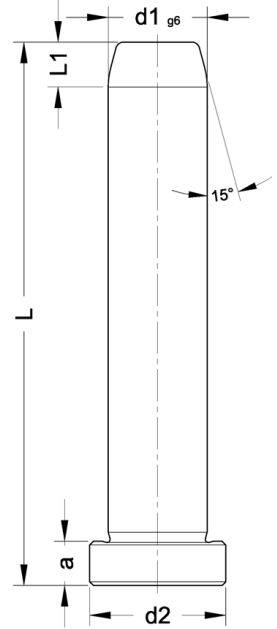

| Sipariş Kodu | Ø d1 | L | L1 | d2 | a |
|--------------|---------|-----|----|----|----|
| D01D_20160 | 20 | 160 | 7 | 24 | 8 |
| 180 | | 180 | | | |
| 200 | | 200 | | | |
| 240 | | 240 | | | |
| D01D_22080 | 22 | 80 | 7 | 26 | 15 |
| 100 | | 100 | | | |
| 120 | | 120 | | | |
| 140 | | 140 | | | |
| 160 | | 160 | | | |
| 180 | | 180 | | | |
| 200 | | 200 | | | |
| 220 | | 220 | | | |
| 240 | | 240 | | | |
| 300 | | 300 | | | |
| D01D_24080 | 24 | 80 | 7 | 28 | 15 |
| 100 | | 100 | | | |
| 120 | | 120 | | | |
| 140 | | 140 | | | |
| 160 | | 160 | | | |
| 180 | | 180 | | | |
| 200 | | 200 | | | |
| 220 | | 220 | | | |
| 240 | | 240 | | | |
| 300 | | 300 | | | |
| D01D_30100 | 30 | 100 | 7 | 36 | 15 |
| 120 | | 120 | | | |
| 140 | | 140 | | | |
| 160 | | 160 | | | |
| 180 | | 180 | | | |
| 200 | | 200 | | | |
| 220 | | 220 | | | |
| 240 | | 240 | | | |
| 300 | | 300 | | | |
| 360 | | 360 | | | |
| D01D_40160 | 40 | 160 | 10 | 48 | 15 |
| 180 | | 180 | | | |
| 200 | | 200 | | | |
| 220 | | 220 | | | |
| 240 | | 240 | | | |
| 280 | | 280 | | | |
| 300 | | 300 | | | |
| 320 | | 320 | | | |

D01D

Kolon / Guide Pillar

Malzeme - Material : Asil Çelik 1.1213 (Cf 53)
 Sertlik - Hardness : 62± 2 HRC
 Isıl İşlem - Heat Treatment : İndüksiyon (Induction)
 DIN ISO 8404 - A



| Sipariş Kodu | Ø d1 | L | L1 | d2 | a |
|--------------|---------|-----|----|----|----|
| D01D_40360 | 40 | 360 | 10 | 48 | 15 |
| D01D_50160 | 50 | 160 | 10 | 58 | 15 |
| 200 | | 200 | | | |
| 240 | | 240 | | | |
| 300 | | 300 | | | |
| 360 | | 360 | | | |

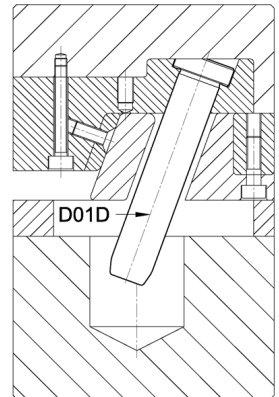
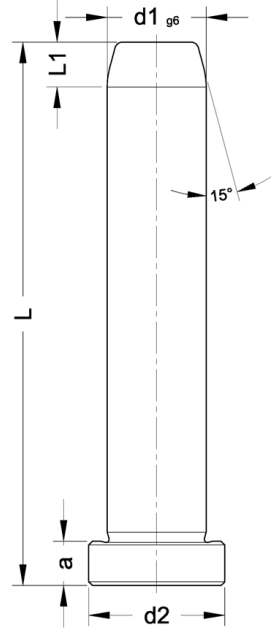

D08

Kolon / Guide Pillar

Malzeme - Material : Asil Çelik 1.1213 (Cf 53)
 Sertlik - Hardness : 62 ± 2 HRC
 Isil İşlem - Heat Treatment : İndüksiyon (Induction)



| Sipariş Kodu | $d1$ | L | L1 | d2 | a |
|--------------|------|-----|----|----|---|
| D08_12080 | 12 | 80 | 4 | 16 | 4 |
| 100 | | 100 | | | |
| 120 | | 120 | | | |
| D08_18120 | 18 | 120 | 7 | 22 | 6 |
| 140 | | 140 | | | |
| 160 | | 160 | | | |
| D08_30160 | 30 | 160 | 7 | 36 | 6 |
| 200 | | 200 | | | |
| 240 | | 240 | | | |

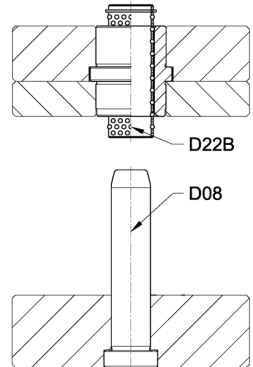
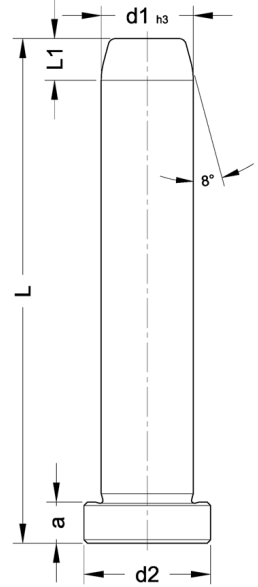

D09

Kolon / Guide Pillar

Malzeme - Material : Asil Çelik 1.1213 (Cf 53)
 Sertlik - Hardness : 62 ± 2 HRC
 Isıl İşlem - Heat Treatment : İndüksiyon (Induction)
 DIN 9825 - 2



| Sipariş Kodu | \varnothing d1 | L | L1 |
|--------------|---------------------|-----|----|
| D09_12100 | 12 | 100 | 6 |
| 125 | | 125 | |
| D09_18125 | 18 | 125 | 6 |
| 160 | | 160 | |
| D09_30160 | 30 | 160 | 7 |
| 240 | | 240 | |

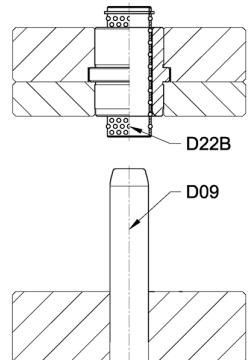
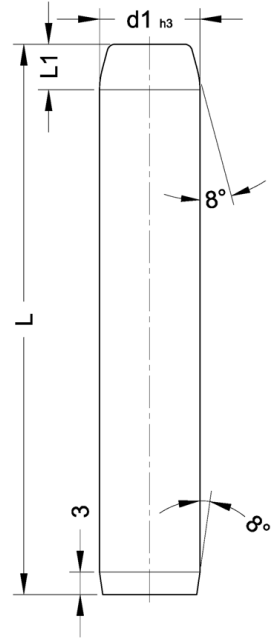

D22B

Bilyalı Burç / Guide Bush with Ball Cage

Malzeme - Material : Asil Çelik 1.3505 (100Cr6)
 Sertlik - Hardness : 62± 2 HRC
 Isil İşlem - Heat Treatment : Sertleştirme (Hardened)

Malzeme - Material : Ms58
 Bilya Malzemesi - Ball Material : 1.3505 (100Cr6)



| Sipariş Kodu | ∅ d1 | L1 | Hmax | L4 | L | L2 | d2 | d3 | d4 | L3 |
|--------------|------|----|------|-----|----|----|----|----|----|----|
| D22B_1240 | 12 | 40 | 50 | 2.1 | 24 | 6 | 16 | 22 | 26 | 18 |
| 56 | | 56 | 82 | | | | | | | |
| D22B_1845 | 18 | 45 | 44 | 3 | 34 | 11 | 24 | 30 | 35 | 23 |
| 56 | | 56 | 66 | | | | | | | |
| 71 | | 71 | 96 | | | | | | | |
| D22B_3056 | 30 | 56 | 32 | 4.8 | 54 | 21 | 38 | 46 | 52 | 33 |
| 75 | | 75 | 70 | | | | | | | |
| 95 | | 95 | 110 | | | | | | | |

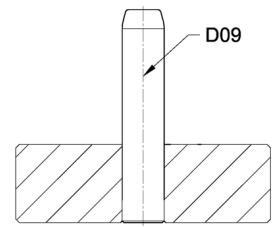
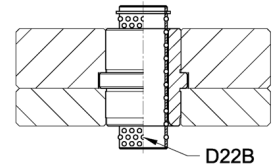
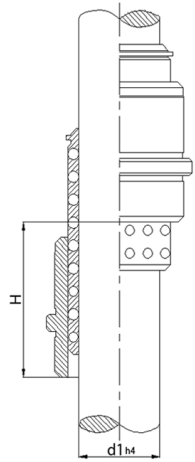
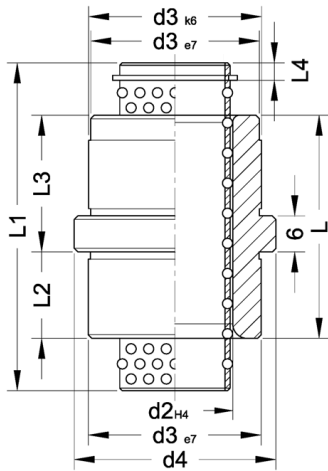
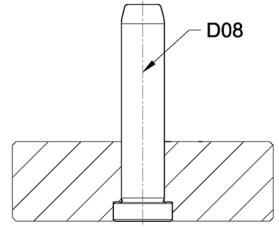
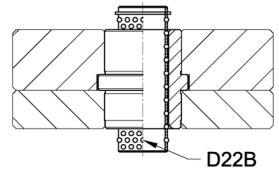

D50

Konik Kilitleme / Locating Unit

Malzeme - Material : Asil Çelik 1.7131 (16MnCr5)
 Sertlik - Hardness : 62± 2 HRC
 Isil İşlem - Heat Treatment : Sementasyon (Case Hardened)
 ≈DIN ISO 8406



| Sipariş Kodu | Ø | | | | | | | | |
|--------------|----|----|----|-----|------|------|-----|-----|-----|
| | d1 | L | L1 | L2 | L3 | L4 | L5 | L6 | d2 |
| D50_12 | 12 | 34 | 16 | 4.5 | 9.6 | 8.6 | 8 | 7.5 | M4 |
| D50_14 | 14 | 34 | 16 | 6 | 12.4 | 6 | 7.5 | 8 | M5 |
| D50_16 | 16 | 34 | 16 | 6 | 12.4 | 5.8 | 7.5 | 8 | M5 |
| D50_20 | 20 | 54 | 26 | 9 | 19.7 | 10.6 | 12 | 9.5 | M8 |
| D50_25 | 25 | 54 | 26 | 10 | 19.7 | 9.2 | 11 | 11 | M8 |
| D50_30 | 30 | 72 | 35 | 14 | 25 | 12.2 | 15 | 13 | M10 |
| D50_32 | 32 | 72 | 35 | 14 | 25 | 12.2 | 15 | 13 | M10 |
| D50_42 | 42 | 92 | 45 | 18 | 27 | 16.8 | 16 | 13 | M10 |

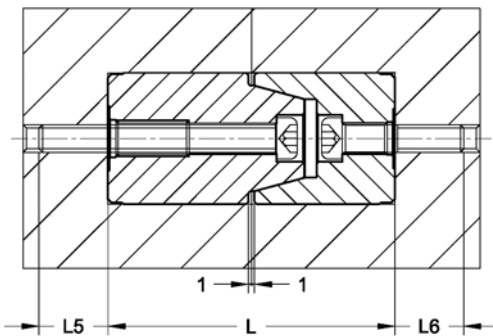
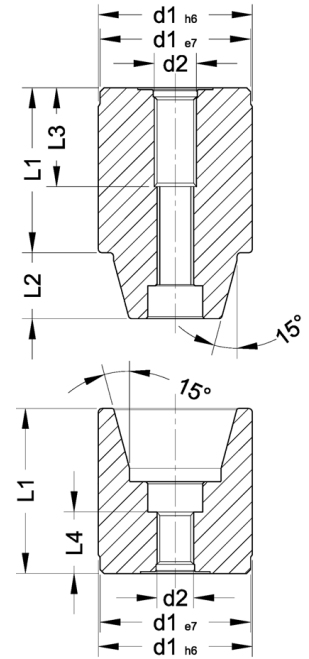

Sac Kalıbı Ürünleri

Cutting Mould Components

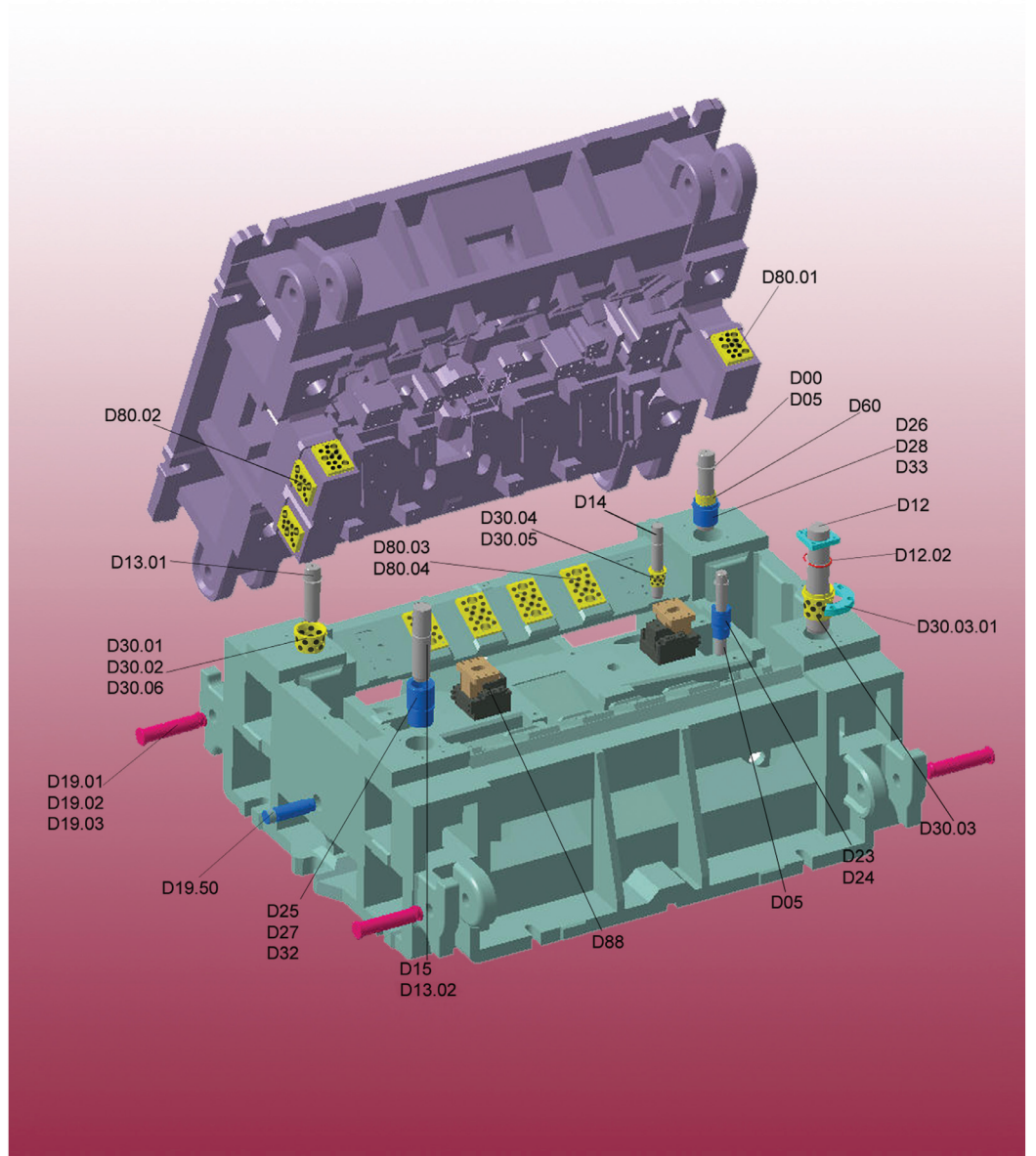

D00

Kolon / Guide Pillar

Malzeme - Material : Asil Çelik 1.1213 (Cf 53)
 Sertlik - Hardness : 62± 2 HRC
 Isil İşlem - Heat Treatment : İndüksiyon (Induction)



| Sipariş Kodu | d1 | Sipariş Kodu | d1 | L1 | L2 | d3 | M |
|--------------|----|--------------|----|-----|----|----|-----|
| D00_1510020 | 15 | D00_1610020 | 16 | 100 | 20 | 22 | 1x8 |
| 11220 | | 11220 | | 112 | | | |
| 12520 | | 12520 | | 125 | | | |
| 14020 | | 14020 | | 140 | | | |
| 16020 | | 16020 | | 160 | | | |
| 18020 | | 18020 | | 180 | | | |
| 20020 | | 20020 | | 200 | | | |
| D00_1910023 | 19 | D00_2010023 | 20 | 100 | 23 | 25 | 8 |
| 11223 | | 11223 | | 112 | | | |
| 12523 | | 12523 | | 125 | | | |
| 14023 | | 14023 | | 140 | | | |
| 16023 | | 16023 | | 160 | | | |
| 18023 | | 18023 | | 180 | | | |
| 20023 | | 20023 | | 200 | | | |
| D00_2410030 | 24 | D00_2510030 | 25 | 100 | 30 | 32 | 8 |
| 11230 | | 11230 | | 112 | | | |
| 12530 | | 12530 | | 125 | | | |
| 14030 | | 14030 | | 140 | | | |
| 16030 | | 16030 | | 160 | | | |
| 18030 | | 18030 | | 180 | | | |
| 20030 | | 20030 | | 200 | | | |
| 22430 | | 22430 | | 224 | | | |
| 25030 | | 25030 | | 250 | | | |
| D00_3011237 | 30 | D00_3211237 | 32 | 112 | 37 | 40 | 8 |
| 12537 | | 12537 | | 125 | | | |
| 14037 | | 14037 | | 140 | | | |
| 16037 | | 16037 | | 160 | | | |
| 18037 | | 18037 | | 180 | | | |
| 20037 | | 20037 | | 200 | | | |
| 22437 | | 22437 | | 224 | | | |
| 25037 | | 25037 | | 250 | | | |
| 28037 | | 28037 | | 280 | | | |
| 31537 | | 31537 | | 315 | | | |
| D00_3812537 | 38 | D00_4012537 | 40 | 125 | 37 | 50 | 8 |
| 14037 | | 14037 | | 140 | | | |
| 16037 | | 16037 | | 160 | | | |
| 18037 | | 18037 | | 180 | | | |
| 20037 | | 20037 | | 200 | | | |
| 22437 | | 22437 | | 224 | | | |
| 25037 | | 25037 | | 250 | | | |
| 28037 | | 28037 | | 280 | | | |
| 31537 | | 31537 | | 315 | | | |

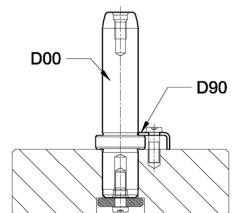
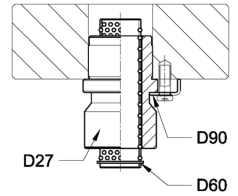
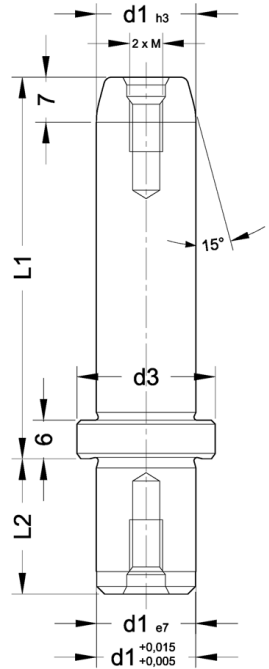

D00

Kolon / Guide Pillar

Malzeme - Material : Asil Çelik 1.1213 (Cf 53)
 Sertlik - Hardness : 62 ± 2 HRC
 Isil İşlem - Heat Treatment : İndüksiyon (Induction)



| Sipariş Kodu | d1 | Sipariş Kodu | d1 | L1 | L2 | d3 | M |
|--------------|----|--------------|----|-----|----|----|----|
| D00_3835537 | 38 | D00_4035537 | 40 | 355 | 37 | 50 | 8 |
| D00_4814047 | 48 | D00_5014047 | 50 | 140 | 47 | 63 | 8 |
| 16047 | | 16047 | | 160 | | | |
| 18047 | | 18047 | | 180 | | | |
| 20047 | | 20047 | | 200 | | | |
| 22447 | | 22447 | | 224 | | | |
| 25047 | | 25047 | | 250 | | | |
| 28047 | | 28047 | | 280 | | | |
| 31547 | | 31547 | | 315 | | | |
| 35547 | | 35547 | | 355 | | | |
| 40047 | | 40047 | | 400 | | | |
| D00_6016047 | 60 | D00_6316047 | 63 | 160 | 47 | 80 | 8 |
| 18047 | | 18047 | | 180 | | | |
| 20047 | | 20047 | | 200 | | | |
| 22447 | | 22447 | | 224 | | | |
| 25047 | | 25047 | | 250 | | | |
| 28047 | | 28047 | | 280 | | | |
| 31547 | | 31547 | | 315 | | | |
| 35547 | | 35547 | | 355 | | | |
| 40047 | | 40047 | | 400 | | | |
| | | D00_8020060 | 80 | 200 | 60 | 95 | 12 |
| | | 22460 | | 224 | | | |
| | | 25060 | | 250 | | | |
| | | 28060 | | 280 | | | |
| | | 31560 | | 315 | | | |
| | | 35560 | | 355 | | | |
| | | 40060 | | 400 | | | |

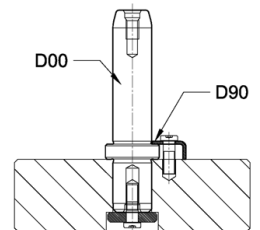
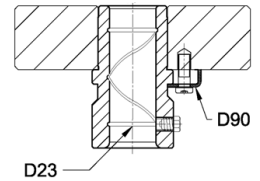
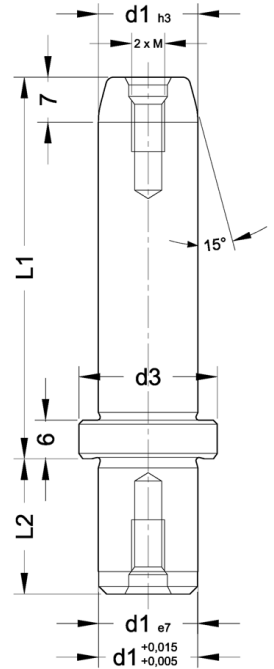

D05

Kolon / Guide Pillar

Malzeme - Material : Asil Çelik 1.1213 (Cf 53)
 Sertlik - Hardness : 62± 2 HRC
 Isıl İşlem - Heat Treatment : İndüksiyon (Induction)



| Sipariş Kodu | Ø d1 | L1 | L2 | d2 | d3 |
|--------------|---------|-----|----|----|----|
| D05_2010025 | 20 | 100 | 25 | 28 | 34 |
| 35 | | | 35 | | |
| D05_2012525 | | 125 | 25 | | |
| 35 | | | 35 | | |
| D05_2014025 | | 140 | 25 | | |
| 35 | | | 35 | | |
| D05_2016025 | | 160 | 25 | | |
| 35 | | | 35 | | |
| D05_2018025 | 180 | 25 | | | |
| 35 | | 35 | | | |
| D05_2510025 | 25 | 100 | 25 | 34 | 39 |
| 35 | | | 35 | | |
| D05_2512525 | | 125 | 25 | | |
| 35 | | | 35 | | |
| D05_2514025 | | 140 | 25 | | |
| 35 | | | 35 | | |
| D05_2516025 | | 160 | 25 | | |
| 35 | | | 35 | | |
| D05_2518025 | 180 | 25 | | | |
| 35 | | 35 | | | |
| D05_2520025 | 200 | 25 | | | |
| 35 | | 35 | | | |
| D05_2522025 | 220 | 25 | | | |
| 35 | | 35 | | | |
| D05_2524025 | 240 | 25 | | | |
| 35 | | 35 | | | |
| D05_3012535 | 30 | 125 | 35 | 39 | 44 |
| 45 | | | 45 | | |
| D05_3014035 | | 140 | 35 | | |
| 45 | | | 45 | | |
| D05_3016035 | | 160 | 35 | | |
| 45 | | | 45 | | |
| D05_3018035 | | 180 | 35 | | |
| 45 | | | 45 | | |
| D05_3020035 | 200 | 35 | | | |
| 45 | | 45 | | | |
| D05_3022035 | 220 | 35 | | | |
| 45 | | 45 | | | |
| D05_3024035 | 240 | 35 | | | |
| 45 | | 45 | | | |
| D05_3026035 | 260 | 35 | | | |
| 45 | | 45 | | | |

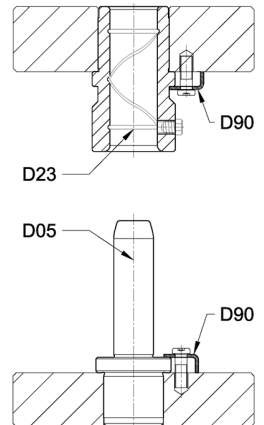
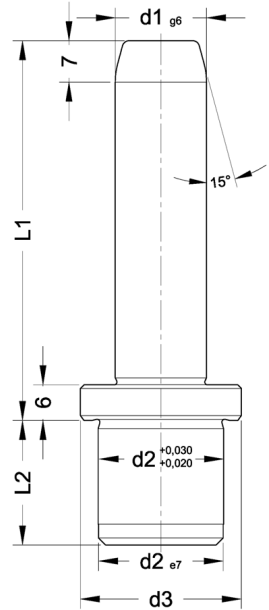

D05

Kolon / Guide Pillar

Malzeme - Material : Asil Çelik 1.1213 (Cf 53)
 Sertlik - Hardness : 62 ± 2 HRC
 Isıl İşlem - Heat Treatment : İndüksiyon (Induction)



| Sipariş Kodu | Ø | L1 | L2 | d2 | d3 |
|--------------|----|-----|----|----|----|
| D05_3028035 | 30 | 280 | 35 | 39 | 44 |
| 45 | | | 45 | | |
| D05_3031535 | 30 | 315 | 35 | 39 | 44 |
| 45 | | | 45 | | |

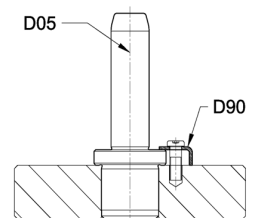
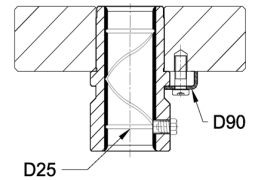
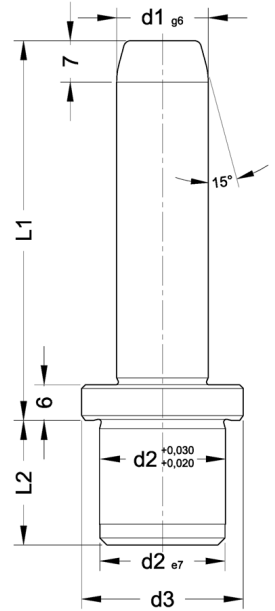

D10

Kolon / Guide Pillar

Malzeme - Material : Asil Çelik 1.1213 (Cf 53)
 Sertlik - Hardness : 62± 2 HRC
 Isıl İşlem - Heat Treatment : İndüksiyon (Induction)



| Sipariş Kodu | Ø d1 | L | L1 | L2 | a |
|--------------|---------|-----|----|-----|---|
| D10_40180 | 40 | 180 | 37 | 77 | 8 |
| 220 | | 220 | | | |
| 260 | | 260 | | | |
| 300 | | 300 | | | |
| 355 | | 355 | | | |
| 400 | | 400 | | | |
| D10_50200 | 50 | 200 | 47 | 95 | 8 |
| 240 | | 240 | | | |
| 280 | | 280 | | | |
| 315 | | 315 | | | |
| 355 | | 355 | | | |
| 400 | | 400 | | | |
| D10_63240 | 63 | 240 | 60 | 120 | 8 |
| 280 | | 280 | | | |
| 315 | | 315 | | | |
| 355 | | 355 | | | |
| 400 | | 400 | | | |
| 450 | | 450 | | | |
| D10_80240 | 80 | 240 | 60 | 120 | 8 |
| 280 | | 280 | | | |
| 315 | | 315 | | | |
| 355 | | 355 | | | |
| 400 | | 400 | | | |
| 450 | | 450 | | | |
| 500 | 500 | | | | |

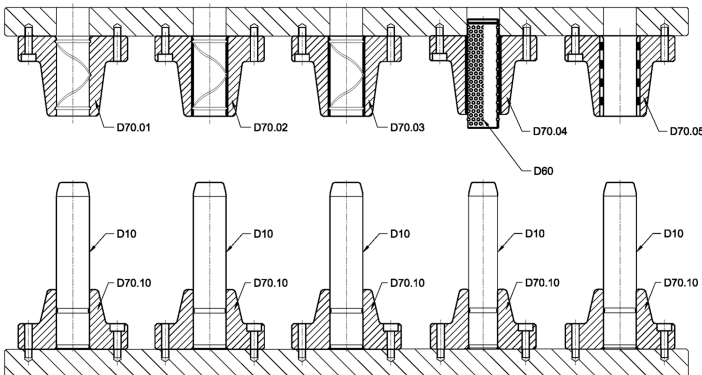
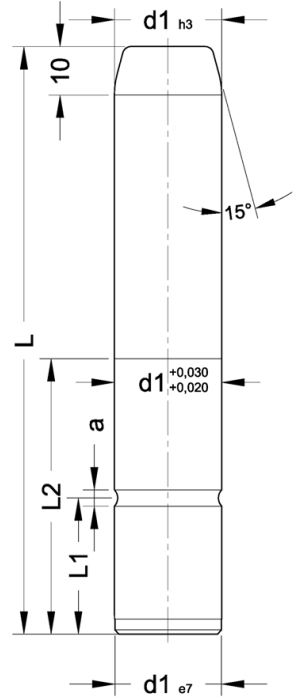

D11

Kolon / Guide Pillar

Malzeme - Material : Asil Çelik 1.1213 (Cf 53)
 Sertlik - Hardness : 62 ± 2 HRC
 Isil İşlem - Heat Treatment : İndüksiyon (Induction)



| Sipariş Kodu | Ø d1 | L | L1 | L2 | a |
|--------------|---------|-----|----|----|---|
| D11_40160 | 40 | 160 | 25 | 50 | 8 |
| 180 | | 180 | | | |
| 200 | | 200 | | | |
| 225 | | 225 | | | |
| 250 | | 250 | | | |
| 280 | | 280 | | | |
| D11_50160 | 50 | 160 | 35 | 70 | 8 |
| 180 | | 180 | | | |
| 200 | | 200 | | | |
| 225 | | 225 | | | |
| 250 | | 250 | | | |
| 280 | | 280 | | | |
| 315 | 315 | | | | |

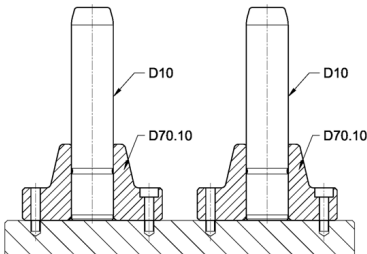
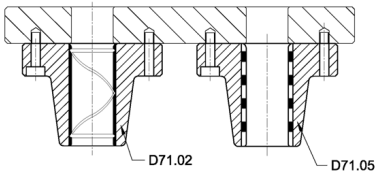
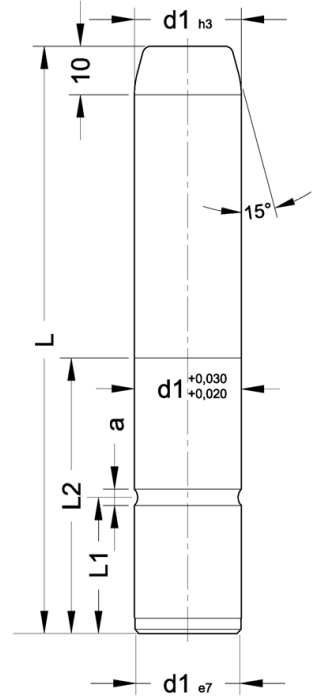

D12

Kolon / Guide Pillar - AFNOR

Malzeme - Material : Asil Çelik 1.1213 (Cf 53)
 Sertlik - Hardness : 62± 2 HRC
 Isıl İşlem - Heat Treatment : İndüksiyon (Induction)



| | | | Ø | | | | | | | | |
|--------------|----------------|--------------------|-----|-----|-----|-----|-----|-----|----|-----|-----|
| Sipariş Kodu | PSA Mabec Code | RENAULT Mabec Code | d1 | L | L1 | L2 | a | | | | |
| D12_025100 | | | 25 | 100 | 8 | 25 | 2.5 | | | | |
| 125 | | R100 018 363 | | 125 | | | | | | | |
| 140 | | | | 140 | | | | | | | |
| 160 | | | | 160 | | | | | | | |
| 180 | | | | 180 | | | | | | | |
| 200 | | | | 200 | | | | | | | |
| 220 | | | | 220 | | | | | | | |
| D12_032125 | | | 32 | 125 | 10 | 32 | 4.2 | | | | |
| 140 | | P446 116 817 | | 140 | | | | | | | |
| 160 | | P446 116 815 | | 160 | | | | | | | |
| 180 | | | | 180 | | | | | | | |
| 200 | | P446 116 816 | | 200 | | | | | | | |
| 220 | | | | 220 | | | | | | | |
| 250 | | | | 250 | | | | | | | |
| D12_040180 | P446 117 470 | | 40 | 180 | 12 | 63 | 4.2 | | | | |
| 200 | P446 117 401 | | | 200 | | | | | | | |
| 220 | P446 117 476 | | | 220 | | | | | | | |
| 250 | | | | 250 | | | | | | | |
| 280 | | | | 280 | | | | | | | |
| 315 | | | | 315 | | | | | | | |
| D12_050200 | | | | 50 | | | | 200 | 16 | 80 | 4.2 |
| 220 | P446 118 170 | | 220 | | | | | | | | |
| 224 | | P446 118 100 | 224 | | | | | | | | |
| 250 | P446 118 174 | | 250 | | | | | | | | |
| 280 | P446 118 101 | P446 118 101 | 280 | | | | | | | | |
| 315 | | | 315 | | | | | | | | |
| 355 | | | 355 | | | | | | | | |
| 400 | | | 400 | | | | | | | | |
| D12_063250 | P446 118 701 | P446 118 701 | 63 | | 250 | 16 | 100 | 6.2 | | | |
| 280 | | P446 118 707 | | | 280 | | | | | | |
| 315 | P446 118 702 | P446 118 702 | | 315 | | | | | | | |
| 355 | | | | 355 | | | | | | | |
| 400 | | | | 400 | | | | | | | |
| D12_080315 | P446 119 200 | P446 119 200 | 80 | 315 | 16 | 125 | 6.2 | | | | |
| 355 | P446 119 270 | P446 119 201 | | 355 | | | | | | | |
| 400 | | R100 221 692 | | 400 | | | | | | | |
| 450 | | | | 450 | | | | | | | |
| D12_100355 | | | | 100 | | | | 355 | 16 | 160 | 6.2 |
| 400 | | P446 119 800 | 400 | | | | | | | | |
| 450 | | P446 119 801 | 450 | | | | | | | | |
| 500 | | | 500 | | | | | | | | |

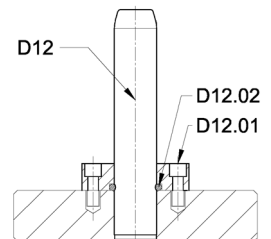
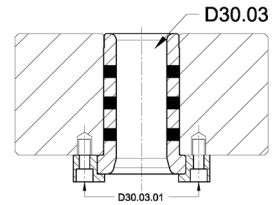
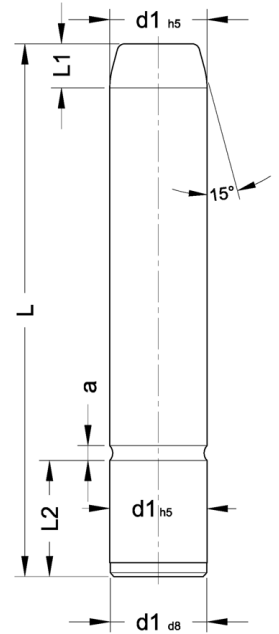

D13.01

Kolon / Guide Pillar

Malzeme - Material : Asil Çelik 1.1213 (Cf 53)
 Sertlik - Hardness : 62 ± 2 HRC
 Isil İşlem - Heat Treatment : İndüksiyon (Induction)



| | | Ø | | | | |
|---------------|----------------------|-----|-----|-----|-----|----|
| Sipariş Kodu | FORD CODE WDX1370 | d1 | L | d2 | L2 | L1 |
| D13.01_025140 | 07025140 | 25 | 140 | 33 | 40 | 4 |
| 160 | 07025160 | | 160 | | | |
| 180 | 07025180 | | 180 | | | |
| D13.01_032140 | 07032140 | 32 | 140 | 40 | 45 | 8 |
| 160 | 07032160 | | 160 | | | |
| 180 | 07032180 | | 180 | | | |
| 200 | 07032200 | | 200 | | | |
| D13.01_040160 | 07040160 | 40 | 160 | 50 | 56 | 8 |
| 180 | 07040180 | | 180 | | | |
| 200 | 07040200 | | 200 | | | |
| 225 | 07040225 | | 225 | | | |
| 250 | 07040250 | | 250 | | | |
| D13.01_050160 | 07050160 | 50 | 160 | 60 | 70 | 10 |
| 180 | 07050180 | | 180 | | | |
| 200 | 07050200 | | 200 | | | |
| 225 | 07050225 | | 225 | | | |
| 250 | 07050250 | | 250 | | | |
| 280 | 07050280 | | 280 | | | |
| 315 | 07050315 | | 315 | | | |
| D13.01_063200 | 07063200 | 63 | 200 | 80 | 80 | 10 |
| 225 | 07063225 | | 225 | | | |
| 250 | 07063250 | | 250 | | | |
| 280 | 07063280 | | 280 | | | |
| 315 | 07063315 | | 315 | | | |
| 355 | 07063355 | | 355 | | | |
| D13.01_080250 | 07080250 | 80 | 250 | 90 | 100 | 10 |
| 280 | 07080280 | | 280 | | | |
| 315 | 07080315 | | 315 | | | |
| 355 | 07080355 | | 355 | | | |
| 400 | 07080400 | | 400 | | | |
| D13.01_100315 | 07100315 | 100 | 315 | 110 | 125 | 10 |
| 355 | 07100355 | | 355 | | | |
| 400 | 07100400 | | 400 | | | |
| 500 | 07100500 | | 500 | | | |

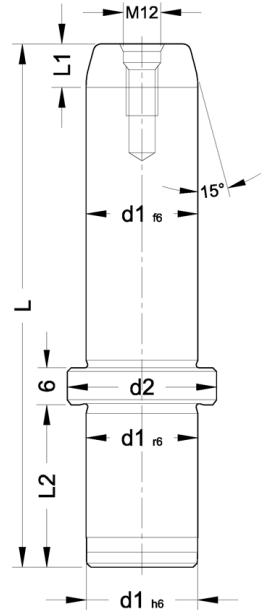

1xM12 Dış Sadece Ø80 ve Ø100
 1xM12 Guide Post only Ø80 and Ø100

D13.02

Kolon / Guide Pillar

Malzeme - Material : Asil Çelik 1.1213 (Cf 53)
 Sertlik - Hardness : 62± 2 HRC
 Isil İşlem - Heat Treatment : İndüksiyon (Induction)
 DIN 9833 / ISO 9182-3



| | | Ø | | | |
|---------------|----------------------|-----|-----|-----|----|
| Sipariş Kodu | FORD CODE WDX1370 | d1 | L | L2 | L1 |
| D13.02_025140 | 08025140 | 25 | 140 | 40 | 4 |
| 160 | 08025160 | | 160 | | |
| 180 | 08025180 | | 180 | | |
| D13.02_032140 | 08032140 | 32 | 140 | 45 | 8 |
| 160 | 08032160 | | 160 | | |
| 180 | 08032180 | | 180 | | |
| 200 | 08032200 | | 200 | | |
| D13.02_040160 | 08040160 | 40 | 160 | 56 | 8 |
| 180 | 08040180 | | 180 | | |
| 200 | 08040200 | | 200 | | |
| 225 | 08040225 | | 225 | | |
| 250 | 08040250 | | 250 | | |
| D13.02_050160 | 08050160 | 50 | 160 | 70 | 10 |
| 180 | 08050180 | | 180 | | |
| 200 | 08050200 | | 200 | | |
| 225 | 08050225 | | 225 | | |
| 250 | 08050250 | | 250 | | |
| 280 | 08050280 | | 280 | | |
| 315 | 08050315 | | 315 | | |
| D13.02_063200 | 08063200 | 63 | 200 | 80 | 10 |
| 225 | 08063225 | | 225 | | |
| 250 | 08063250 | | 250 | | |
| 280 | 08063280 | | 280 | | |
| 315 | 08063315 | | 315 | | |
| 355 | 08063355 | | 355 | | |
| D13.02_080250 | 08080250 | 80 | 250 | 100 | 10 |
| 280 | 08080280 | | 280 | | |
| 315 | 08080315 | | 315 | | |
| 355 | 08080355 | | 355 | | |
| 400 | 08080400 | | 400 | | |
| D13.02_100315 | 08100315 | 100 | 315 | 125 | 10 |
| 355 | 08100355 | | 355 | | |
| 400 | 08100400 | | 400 | | |
| 500 | 08100500 | | 500 | | |

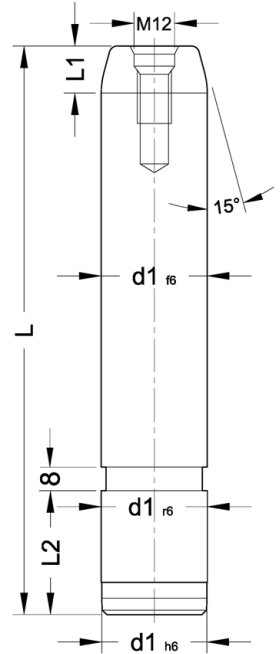

1xM12 Dış Sadece Ø80 ve Ø100
 1xM12 Guide Post only Ø80 and Ø100

D14

Kolon / Guide Pillar

Malzeme - Material : Asil Çelik 1.1213 (Cf 53)
 Sertlik - Hardness : 62 ± 2 HRC
 Isil İşlem - Heat Treatment : İndüksiyon (Induction)
 ≈DIN 9825 / ≈ISO 9182-2



| Sipariş Kodu | d1 | Sipariş Kodu | d1 | L | L1 |
|--------------|----|--------------|----|-----|----|
| D14_15090 | 15 | D14_16090 | 16 | 90 | 4 |
| 100 | | 100 | | 100 | |
| 112 | | 112 | | 112 | |
| 125 | | 125 | | 125 | |
| 140 | | 140 | | 140 | |
| 160 | | 160 | | 160 | |
| 180 | | 180 | | 180 | |
| 200 | | 200 | | 200 | |
| 224 | | 224 | | 224 | |
| D14_19100 | 19 | D14_20100 | 20 | 100 | 4 |
| 112 | | 112 | | 112 | |
| 125 | | 125 | | 125 | |
| 140 | | 140 | | 140 | |
| 160 | | 160 | | 160 | |
| 180 | | 180 | | 180 | |
| 200 | | 200 | | 200 | |
| 224 | | 224 | | 224 | |
| 250 | | 250 | | 250 | |
| D14_24100 | 24 | D14_25100 | 25 | 100 | 6 |
| 112 | | 112 | | 112 | |
| 125 | | 125 | | 125 | |
| 140 | | 140 | | 140 | |
| 160 | | 160 | | 160 | |
| 180 | | 180 | | 180 | |
| 200 | | 200 | | 200 | |
| 224 | | 224 | | 224 | |
| 250 | | 250 | | 250 | |
| 280 | | 280 | | 280 | |
| D14_30125 | 30 | D14_32125 | 32 | 125 | 6 |
| 140 | | 140 | | 140 | |
| 160 | | 160 | | 160 | |
| 180 | | 180 | | 180 | |
| 200 | | 200 | | 200 | |
| 224 | | 224 | | 224 | |
| 250 | | 250 | | 250 | |
| 280 | | 280 | | 280 | |
| 315 | | 315 | | 315 | |
| D14_38160 | 38 | D14_40160 | 40 | 160 | 6 |
| 180 | | 180 | | 180 | |
| 200 | | 200 | | 200 | |
| 224 | | 224 | | 224 | |
| 250 | | 250 | | 250 | |

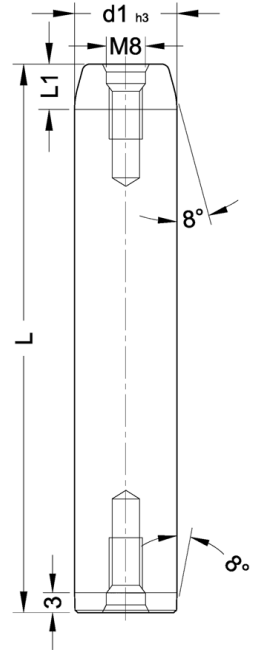

Not: Bu ürünler stok tutulmamaktadır. Fiyat ve termin için bayimiz ile irtibata geçiniz.

D14

Kolon / Guide Pillar

Malzeme - Material : Asil Çelik 1.1213 (Cf 53)
 Sertlik - Hardness : 62 ± 2 HRC
 Isil İşlem - Heat Treatment : İndüksiyon (Induction)
 ≈DIN 9825 / ≈ISO 9182-2



| Sipariş Kodu | d1 | Sipariş Kodu | d1 | L | L1 |
|--------------|-----|--------------|----|-----------|----|
| D14_38280 | 38 | D14_40280 | 40 | 280 | 6 |
| 315 | | 315 | | | |
| 355 | | 355 | | | |
| 400 | | 400 | | | |
| D14_48180 | 48 | D14_50180 | 50 | 180 | 8 |
| 200 | | 200 | | | |
| 224 | | 224 | | | |
| 250 | | 250 | | | |
| 280 | | 280 | | | |
| 315 | | 315 | | | |
| 355 | | 355 | | | |
| 400 | | 400 | | | |
| 450 | | 450 | | | |
| D14_60250 | | 60 | | D14_63250 | |
| 280 | 280 | | | | |
| 315 | 315 | | | | |
| 355 | 355 | | | | |
| 400 | 400 | | | | |
| 450 | 450 | | | | |
| 500 | 500 | | | | |
| | | D14_80280 | 80 | 280 | 8 |
| | | 315 | | | |
| | | 355 | | | |
| | | 400 | | | |
| | | 450 | | | |
| | | 500 | | | |

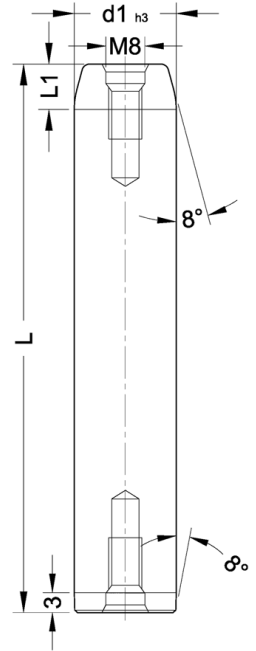

Not: Bu ürünler stok tutulmamaktadır. Fiyat ve termin için bayimiz ile irtibata geçiniz.

D15

Kolon / Guide Pillar

Malzeme - Material : Çelik (Steel)
 Sertlik - Hardness : 60 ± 2 HRC
 Isil İşlem - Heat Treatment : İndüksiyon (Induction)
 DIN 9833 / ISO 9182-3



| Sipariş Kodu | Ø | L | d3 | d5 | L1 | L2 |
|--------------|----|-----|----|----|----|----|
| D15_025125 | 25 | 125 | | | 8 | 40 |
| 140 | | 140 | | | | |
| 160 | | 160 | | | | |
| 180 | | 180 | | | | |
| 200 | | 200 | | | | |
| 224 | | 224 | | | | |
| D15_032125 | 32 | 125 | | | 8 | 45 |
| 140 | | 140 | | | | |
| 160 | | 160 | | | | |
| 180 | | 180 | | | | |
| 200 | | 200 | | | | |
| 224 | | 224 | | | | |
| 250 | | 250 | | | | |
| D15_040140 | 40 | 140 | | | 8 | 56 |
| 160 | | 160 | | | | |
| 180 | | 180 | | | | |
| 200 | | 200 | | | | |
| 224 | | 224 | | | | |
| 250 | | 250 | | | | |
| 280 | | 280 | | | | |
| D15_050160 | 50 | 160 | | | 10 | 70 |
| 180 | | 180 | | | | |
| 200 | | 200 | | | | |
| 224 | | 224 | | | | |
| 250 | | 250 | | | | |
| 280 | | 280 | | | | |
| 315 | | 315 | | | | |
| 355 | | 355 | | | | |
| D15_063180 | 63 | 180 | | | 10 | 80 |
| 200 | | 200 | | | | |
| 224 | | 224 | | | | |
| 250 | | 250 | | | | |
| 280 | | 280 | | | | |
| 315 | | 315 | | | | |
| 355 | | 355 | | | | |
| 400 | | 400 | | | | |

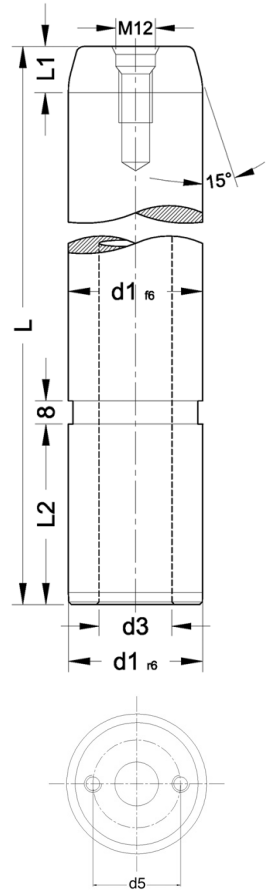

Ød1=80'e Kadar Merkez Deliksiz

Ød1=80 Merkezde 1xM12 Diş

Ød1=100'den Sonra Merkez Deliği ve
2xM12 Diş

Up to Ød1=80 without central hole

By Ød1=80 1 lifting thread M12

From Ød1=100 with central hole (through) and
with 2 lifting thread M12

D15

Kolon / Guide Pillar

Malzeme - Material : Çelik (Steel)
 Sertlik - Hardness : 60 ± 2 HRC
 Isil İşlem - Heat Treatment : İndüksiyon (Induction)
 DIN 9833 / ISO 9182-3



| | | Ø | | | | | |
|--------------|----------------|-----|-----|----|-----|----|-----|
| Sipariş Kodu | PSA Mabec Code | d1 | L | d3 | d5 | L1 | L2 |
| D15_080224 | | 80 | 224 | | | 10 | 100 |
| 250 | 250 | | | | | | |
| 280 | 280 | | | | | | |
| 315 | 315 | | | | | | |
| 355 | 355 | | | | | | |
| 400 | 400 | | | | | | |
| 450 | 450 | | | | | | |
| 500 | 500 | | | | | | |
| D15_100250 | | | 100 | | | | |
| 280 | 280 | | | | | | |
| 315 | 315 | | | | | | |
| 355 | Z000499647 | 355 | | | | | |
| 400 | 400 | | | | | | |
| 450 | 450 | | | | | | |
| D15_125315 | | 125 | 315 | 65 | 90 | 12 | 140 |
| 355 | 355 | | | | | | |
| 400 | Z000499648 | | 400 | | | | |
| 450 | 450 | | | | | | |
| 500 | 500 | | | | | | |
| D15_160400 | | 160 | 400 | 95 | 132 | 12 | 180 |
| 450 | 450 | | | | | | |
| 500 | 500 | | | | | | |
| 560 | 560 | | | | | | |

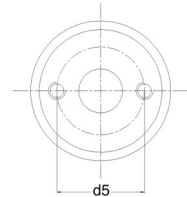
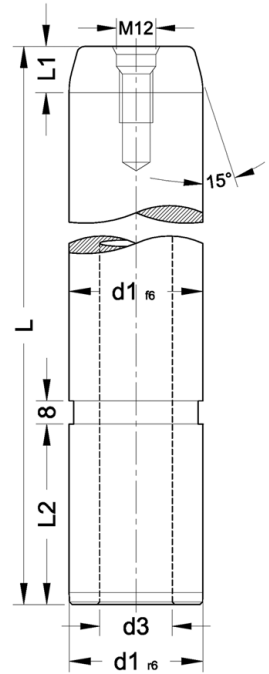

Ø 100 dahil üzeri ürünler stok tutulmamaktadır.
Fiyat ve termin için bayimiz ile irtibata geçiniz.

Ød1=80'e Kadar Merkez Deliksiz
Ød1=80 Merkezde 1xM12 Diş
Ød1=100'den Sonra Merkez Deliği ve
2xM12 Diş

Up to Ød1=80 without central hole
 By Ød1=80 1 lifting thread M12
 From Ød1=100 with central hole (through) and
 with 2 lifting thread M12

D23

Burç / Guide Bush

Malzeme - Material : Asil Çelik 1.7131 (16MnCr5)
 Sertlik - Hardness : 62± 2 HRC
 Isıl İşlem - Heat Treatment : Sementasyon (Case Hardened)



| Sipariş Kodu | d1 | L | L1 | d2 | d3 |
|--------------|----|-----|----|-----|-----|
| D23_2007026 | 20 | 70 | 26 | 28 | 34 |
| 36 | | | 36 | | |
| D23_2508026 | 25 | 80 | 26 | 34 | 39 |
| 36 | | | 36 | | |
| D23_3009036 | 30 | 90 | 36 | 39 | 44 |
| 46 | | | 46 | | |
| D23_4010036 | 40 | 100 | 36 | 50 | 54 |
| 10836 | | 108 | 36 | 58 | 65 |
| 10046 | | 100 | 46 | 50 | 54 |
| D23_5012046 | 50 | 120 | 46 | 60 | 64 |
| 56 | | | 56 | | |
| 12756 | | 127 | 56 | 70 | 75 |
| D23_6313056 | 63 | 130 | 56 | 80 | 87 |
| 15056 | | 150 | 56 | 85 | 95 |
| D23_8015060 | 80 | 150 | 60 | 105 | 115 |

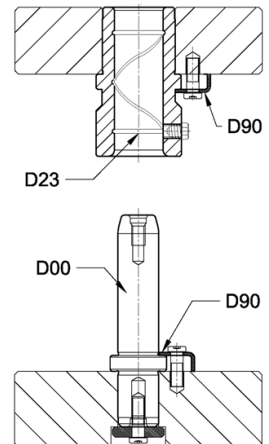
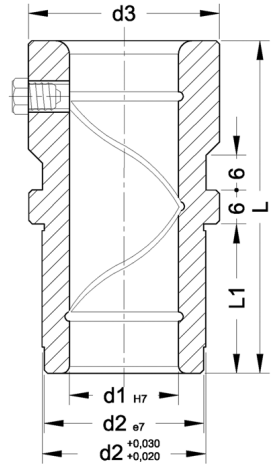

D24

Burç / Guide Bush

Malzeme - Material : Asil Çelik 1.7131 (16MnCr5)
 Sertlik - Hardness : 62± 2 HRC
 Isil İşlem - Heat Treatment : Sementasyon (Case Hardened)



| Sipariş Kodu | d1 | d2 | L | d3 |
|--------------|----|-----|----|-----|
| D24_2002826 | 20 | 28 | 26 | 34 |
| D24_2503426 | 25 | 34 | 26 | 39 |
| D24_3003926 | 30 | 39 | 26 | 44 |
| 36 | | | 36 | |
| D24_4005036 | 40 | 50 | 36 | 54 |
| 46 | | | 46 | |
| 05846 | | 58 | | 65 |
| D24_5006046 | 50 | 60 | 46 | 64 |
| 07046 | | 70 | | 75 |
| D24_6308546 | 63 | 85 | 46 | 95 |
| 56 | | | 56 | |
| D24_8010560 | 80 | 105 | 60 | 115 |

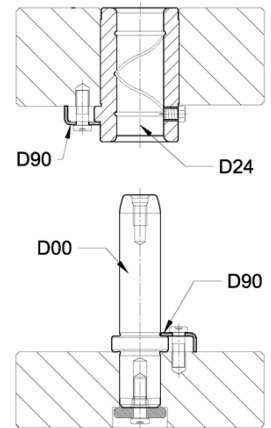
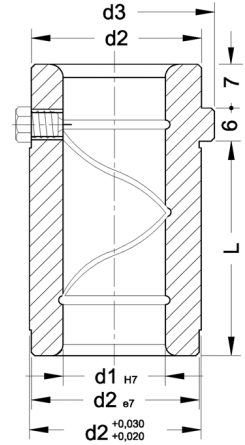

D25

Bronzlu Burç / Guide Bush with Bronze

Malzeme - Material : Asil Çelik 1.1186 (CK40) + Bronze
 Sertlik - Hardness : 52± 2 HRC
 Isıl İşlem - Heat Treatment : İndüksiyon (Induction)
 ISO - 9448



| Sipariş Kodu | Ø | L | L1 | d2 | d3 | d4 |
|--------------|----|-----|----|-----|-----|-----|
| D25_1904323 | 19 | 43 | 23 | 32 | 40 | 39 |
| 05923 | | 59 | | | | |
| 05933 | | | 33 | | | |
| D25_2004323 | 20 | 43 | 23 | 32 | 40 | 39 |
| 05923 | | 59 | | | | |
| 05933 | | | 33 | | | |
| D25_2405923 | 24 | 59 | 23 | 40 | 48 | 46 |
| 07923 | | 79 | | | | |
| 07933 | | | 33 | | | |
| D25_2505923 | 25 | 59 | 23 | 40 | 48 | 46 |
| 07923 | | 79 | | | | |
| 07933 | | | 33 | | | |
| D25_3007530 | 30 | 75 | 30 | 48 | 55 | 53 |
| 09330 | | 93 | | | | |
| 09340 | | | 40 | | | |
| D25_3207530 | 32 | 75 | 30 | 48 | 55 | 53 |
| 09330 | | 93 | | | | |
| 09340 | | | 40 | | | |
| D25_3808237 | 38 | 82 | 37 | 58 | 65 | 63 |
| 10837 | | 108 | | | | |
| 10847 | | | 47 | | | |
| D25_4008237 | 40 | 82 | 37 | 58 | 65 | 63 |
| 10837 | | 108 | | | | |
| 10847 | | | 47 | | | |
| D25_4809747 | 48 | 97 | 47 | 70 | 80 | 77 |
| 12747 | | 127 | | | | |
| 12757 | | | 57 | | | |
| D25_5009747 | 50 | 97 | 47 | 70 | 80 | 77 |
| 12747 | | 127 | | | | |
| 12757 | | | 57 | | | |
| D25_6011660 | 60 | 116 | 60 | 85 | 95 | 92 |
| 15060 | | 150 | | | | |
| D25_6311660 | 63 | 116 | 60 | 85 | 95 | 92 |
| 15060 | | 150 | | | | |
| D25_8012060 | 80 | 120 | 60 | 105 | 118 | 115 |
| 15060 | | 150 | | | | |

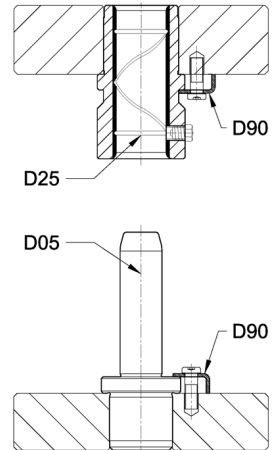
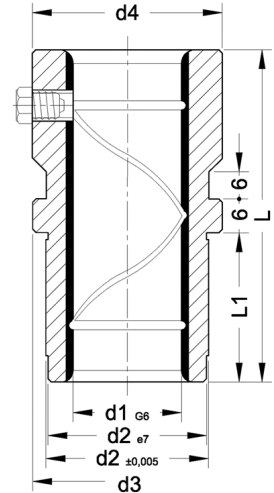

D26

Bronzlu Burç / Guide Bush with Bronze

Malzeme - Material : Asil Çelik 1.1186 (CK40) + Bronze
 Sertlik - Hardness : 52 ± 2 HRC
 Isıl İşlem - Heat Treatment : İndüksiyon (Induction)
 ISO - 9448

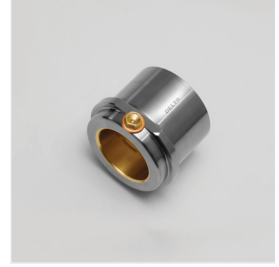

| Sipariş Kodu | Ø | | | d2 | d3 |
|--------------|----|----|----|-----|-----|
| D26_193523 | 19 | 35 | 23 | 32 | 40 |
| 4533 | | 45 | 33 | | |
| D26_203523 | 20 | 35 | 23 | 32 | 40 |
| 4533 | | 45 | 33 | | |
| D26_243523 | 24 | 35 | 23 | 40 | 48 |
| 4533 | | 45 | 33 | | |
| D26_253523 | 25 | 35 | 23 | 40 | 48 |
| 4533 | | 45 | 33 | | |
| D26_304230 | 30 | 42 | 30 | 48 | 55 |
| 5240 | | 52 | 40 | | |
| D26_324230 | 32 | 42 | 30 | 48 | 55 |
| 5240 | | 52 | 40 | | |
| D26_385237 | 38 | 52 | 37 | 58 | 65 |
| 6247 | | 62 | 47 | | |
| D26_405237 | 40 | 52 | 37 | 58 | 65 |
| 6247 | | 62 | 47 | | |
| D26_486547 | 48 | 65 | 47 | 70 | 80 |
| 7557 | | 75 | 57 | | |
| D26_506547 | 50 | 65 | 47 | 70 | 80 |
| 7557 | | 75 | 57 | | |
| D26_608060 | 60 | 80 | 60 | 85 | 95 |
| D26_638060 | 63 | 80 | 60 | 85 | 95 |
| D26_808060 | 80 | 80 | 60 | 105 | 118 |

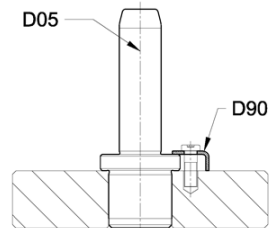
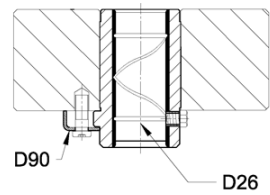
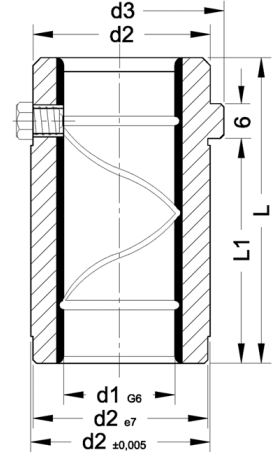

D32

Sinterli Burç / Guide Bush with Sintered

Malzeme - Material : 1.1191 (Ck45) + Sinter
 Sertlik - Hardness : 52 ± 2 HRC
 Isil İşlem - Heat Treatment : İndüksiyon (Induction)



| Sipariş Kodu | d1 | L | L1 | d2 | d3 | d4 |
|--------------|----|-----|----|-----|-----|-----|
| D32_2007026 | 20 | 70 | 26 | 32 | 40 | 38 |
| 36 | | | 36 | | | |
| D32_2508026 | 25 | 80 | 26 | 40 | 47 | 45 |
| 36 | | | 36 | | | |
| D32_3009036 | 30 | 90 | 36 | 48 | 54 | 52 |
| 46 | | | 46 | | | |
| D32_4010036 | 40 | 100 | 36 | 58 | 64 | 62 |
| 46 | | | 46 | | | |
| D32_5012046 | 50 | 120 | 46 | 70 | 78 | 76 |
| 56 | | | 56 | | | |
| D32_6315056 | 63 | 150 | 56 | 85 | 93 | 91 |
| D32_8015060 | 80 | 150 | 60 | 105 | 118 | 115 |

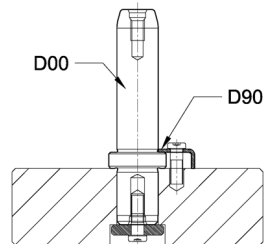
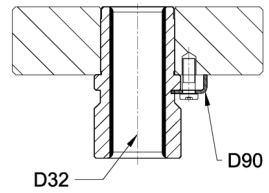
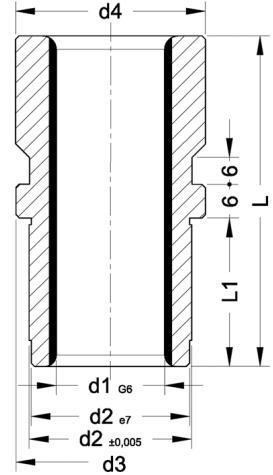

D33

Sinterli Burç / Guide Bush with Sintered

Malzeme - Material : 1.1191 (Ck45) + Sinter
 Sertlik - Hardness : 52± 2 HRC
 Isıl İşlem - Heat Treatment : Indüksiyon (Induction)



| Sipariş Kodu | d1 | d2 | L | d3 |
|--------------|----|-----|----|-----|
| D33_2003226 | 20 | 32 | 26 | 40 |
| 36 | | | 36 | |
| D33_2504026 | 25 | 40 | 26 | 47 |
| 36 | | | 36 | |
| D33_3004826 | 30 | 48 | 26 | 54 |
| 36 | | | 36 | |
| D33_4005836 | 40 | 58 | 36 | 64 |
| 46 | | | 46 | |
| D33_5007046 | 50 | 70 | 46 | 78 |
| D33_6308556 | 63 | 85 | 56 | 93 |
| D33_8010560 | 80 | 105 | 60 | 118 |

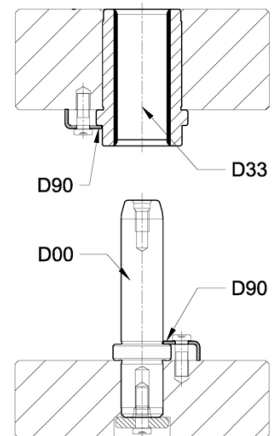
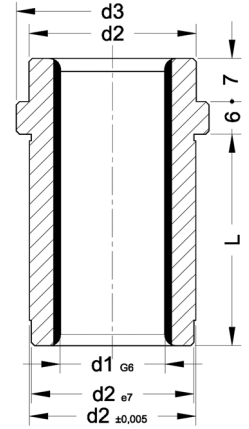

D27

Burç / Ball Bearing Guide Bush

Malzeme - Material : Asil Çelik 1.3505 (100Cr6)
 Sertlik - Hardness : 62± 2 HRC
 Isıl İşlem - Heat Treatment : Sertleştirme (Hardened)
 DIN 9831
 ISO 9448 - 7



| Sipariş Kodu | Ø | | | | | | |
|--------------|----|-----|----|----|----|----|----|
| Sipariş Kodu | d1 | L | L1 | d2 | d3 | d4 | d5 |
| D27_1504323 | 15 | 43 | 23 | 21 | 30 | 34 | 32 |
| 05923 | | 59 | | | | | |
| 05933 | | | 33 | | | | |
| D27_1604323 | 16 | 43 | 23 | 22 | 30 | 34 | 32 |
| 05923 | | 59 | | | | | |
| 05933 | | | 33 | | | | |
| D27_1904323 | 19 | 43 | 23 | 25 | 32 | 40 | 39 |
| 05923 | | 59 | | | | | |
| 05933 | | | 33 | | | | |
| D27_2004323 | 20 | 43 | 23 | 26 | 32 | 40 | 39 |
| 05923 | | 59 | | | | | |
| 05933 | | | 33 | | | | |
| D27_2405923 | 24 | 59 | 23 | 30 | 40 | 48 | 46 |
| 07923 | | 79 | | | | | |
| 07933 | | | 33 | | | | |
| D27_2505923 | 25 | 59 | 23 | 31 | 40 | 48 | 46 |
| 07923 | | 79 | | | | | |
| 07933 | | | 33 | | | | |
| D27_3007530 | 30 | 75 | 30 | 38 | 48 | 55 | 53 |
| 09330 | | 93 | | | | | |
| 09340 | | | 40 | | | | |
| D27_3207530 | 32 | 75 | 30 | 40 | 48 | 55 | 53 |
| 09330 | | 93 | | | | | |
| 09340 | | | 40 | | | | |
| D27_3808237 | 38 | 82 | 37 | 46 | 58 | 65 | 63 |
| 10837 | | 108 | | | | | |
| 10847 | | | 47 | | | | |
| D27_4008237 | 40 | 82 | 37 | 48 | 58 | 65 | 63 |
| 10837 | | 108 | | | | | |
| 10847 | | | 47 | | | | |
| D27_4809747 | 48 | 97 | 47 | 56 | 70 | 80 | 77 |
| 12747 | | 127 | | | | | |
| 12757 | | | 57 | | | | |
| D27_5009747 | 50 | 97 | 47 | 58 | 70 | 80 | 77 |
| 12747 | | 127 | | | | | |
| 12757 | | | 57 | | | | |
| D27_6011660 | 60 | 116 | 60 | 68 | 85 | 95 | 92 |
| 15060 | | 150 | | | | | |
| D27_6311660 | 63 | 116 | 60 | 71 | 85 | 95 | 92 |
| 15060 | | 150 | | | | | |

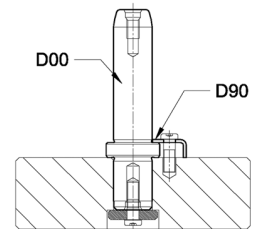
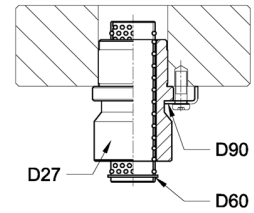
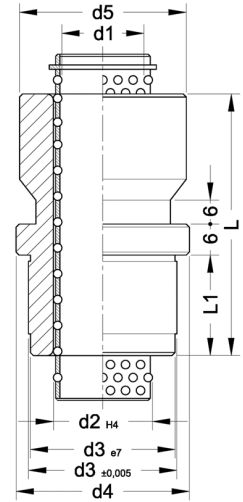

D28

Burç / Ball Bearing Guide Bush

Malzeme - Material : Asil Çelik 1.3505 (100Cr6)
 Sertlik - Hardness : 62 ± 2 HRC
 Isıl İşlem - Heat Treatment : Sertleştirme (Hardened)
 DIN 9831
 ISO 9448 - 7



| Sipariş Kodu | d1 | L | L1 | d2 | d3 | d4 |
|--------------|----|----|----|----|----|----|
| D28_153523 | 15 | 35 | 23 | 21 | 30 | 34 |
| 4533 | | 45 | 33 | | | |
| D28_163523 | 16 | 35 | 23 | 22 | 30 | 34 |
| 4533 | | 45 | 33 | | | |
| D28_193523 | 19 | 35 | 23 | 25 | 32 | 40 |
| 4533 | | 45 | 33 | | | |
| D28_203523 | 20 | 35 | 23 | 26 | 32 | 40 |
| 4533 | | 45 | 33 | | | |
| D28_243523 | 24 | 35 | 23 | 30 | 40 | 48 |
| 4533 | | 45 | 33 | | | |
| D28_253523 | 25 | 35 | 23 | 31 | 40 | 48 |
| 4533 | | 45 | 33 | | | |
| D28_304230 | 30 | 42 | 30 | 38 | 48 | 55 |
| 5240 | | 52 | 40 | | | |
| D28_324230 | 32 | 42 | 30 | 40 | 48 | 55 |
| 5240 | | 52 | 40 | | | |
| D28_385237 | 38 | 52 | 37 | 46 | 58 | 65 |
| 6247 | | 62 | 47 | | | |
| D28_405237 | 40 | 52 | 37 | 48 | 58 | 65 |
| 6247 | | 62 | 47 | | | |
| D28_486547 | 48 | 65 | 47 | 56 | 70 | 80 |
| 7557 | | 75 | 57 | | | |
| D28_506547 | 50 | 65 | 47 | 58 | 70 | 80 |
| 7557 | | 75 | 57 | | | |
| D28_608060 | 60 | 80 | 60 | 68 | 85 | 95 |
| D28_638060 | 63 | 80 | 60 | 71 | 85 | 95 |

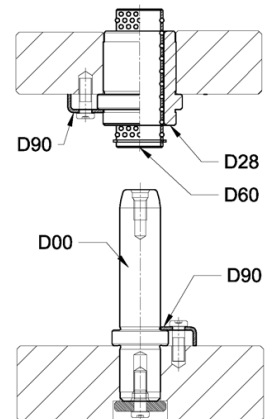
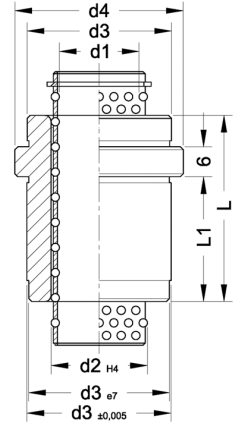

D60

Bilyalı Kafes / Ball Cage

Malzeme - Material : Ms58
 Bilya Malzemesi - Ball Material : 100Cr6 (1.3505)
 DIN 471
 DIN 5401

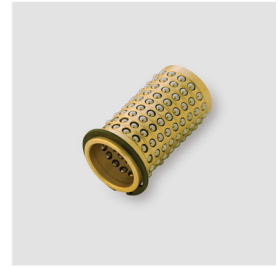

| | Ø | | | | |
|--------------|----|-----|----|----|-----|
| Sipariş Kodu | d1 | L | d2 | d3 | n |
| D60_12040 | 12 | 40 | 16 | 2 | 176 |
| 056 | | 56 | | | 272 |
| D60_15045 | 15 | 45 | 21 | 3 | 140 |
| 056 | | 56 | | | 196 |
| 071 | | 71 | | | 238 |
| D60_16045 | 16 | 45 | 22 | 3 | 140 |
| 056 | | 56 | | | 196 |
| 071 | | 71 | | | 238 |
| D60_18045 | 18 | 45 | 24 | 3 | 176 |
| 056 | | 56 | | | 240 |
| 071 | | 71 | | | 272 |
| D60_19045 | 19 | 45 | 25 | 3 | 180 |
| 056 | | 56 | | | 234 |
| 071 | | 71 | | | 306 |
| 080 | | 80 | | | 342 |
| 095 | | 95 | | | 414 |
| D60_20045 | 20 | 45 | 26 | 3 | 180 |
| 056 | | 56 | | | 234 |
| 071 | | 71 | | | 306 |
| 080 | | 80 | | | 342 |
| 095 | | 95 | | | 414 |
| D60_24045 | 24 | 45 | 30 | 3 | 180 |
| 056 | | 56 | | | 240 |
| 071 | | 71 | | | 280 |
| 080 | | 80 | | | 320 |
| 095 | | 95 | | | 440 |
| 105 | | 105 | | | 480 |
| 120 | | 120 | | | 560 |
| D60_25045 | 25 | 45 | 31 | 3 | 180 |
| 056 | | 56 | | | 240 |
| 071 | | 71 | | | 280 |
| 080 | | 80 | | | 320 |
| 095 | | 95 | | | 440 |
| 105 | | 105 | | | 480 |
| 120 | | 120 | | | 560 |
| D60_30045 | 30 | 45 | 38 | 4 | 140 |
| 056 | | 56 | | | 180 |
| 075 | | 75 | | | 240 |
| 080 | | 80 | | | 280 |
| 095 | | 95 | | | 340 |
| 105 | | 105 | | | 380 |
| 120 | | 120 | | | 420 |
| 140 | | 140 | | | 500 |

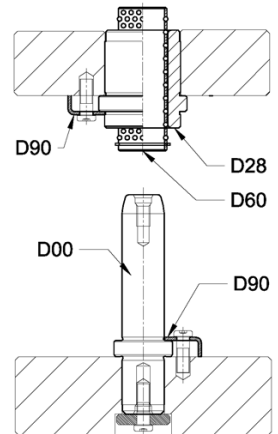
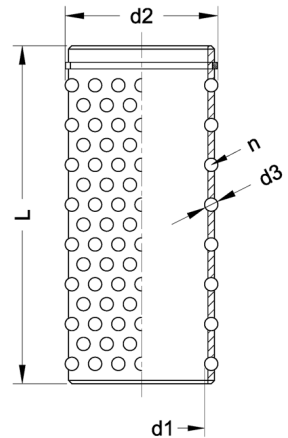

D60

Bilyalı Kafes / Ball Cage

Malzeme - Material : Ms58
 Bilya Malzemesi - Ball Material : 100Cr6 (1.3505)
 DIN 471
 DIN 5401

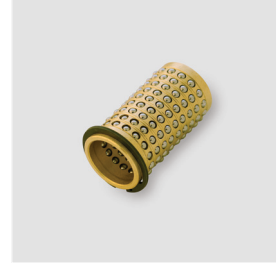

| Sipariş Kodu | Ø d1 | L | d2 | d3 | n | | | |
|--------------|---------|-----|-----|----|-----|----|---|-----|
| D60_32045 | 32 | 45 | 40 | 4 | 140 | | | |
| 056 | | 56 | | | 180 | | | |
| 075 | | 75 | | | 240 | | | |
| 080 | | 80 | | | 280 | | | |
| 095 | | 95 | | | 340 | | | |
| 105 | | 105 | | | 380 | | | |
| 120 | | 120 | | | 420 | | | |
| 140 | | 140 | | | 500 | | | |
| D60_38056 | | 38 | | | 56 | 46 | 4 | 216 |
| 071 | 71 | | 288 | | | | | |
| 080 | 80 | | 336 | | | | | |
| 095 | 95 | | 408 | | | | | |
| 105 | 105 | | 456 | | | | | |
| 120 | 120 | | 528 | | | | | |
| 140 | 140 | | 624 | | | | | |
| 160 | 160 | | 720 | | | | | |
| D60_40056 | 40 | | 56 | 48 | 4 | | | 216 |
| 071 | | 71 | 288 | | | | | |
| 080 | | 80 | 336 | | | | | |
| 095 | | 95 | 408 | | | | | |
| 105 | | 105 | 456 | | | | | |
| 120 | | 120 | 528 | | | | | |
| 140 | | 140 | 624 | | | | | |
| 160 | | 160 | 720 | | | | | |
| D60_48071 | | 48 | 71 | | | 56 | 4 | 360 |
| 080 | 80 | | 390 | | | | | |
| 095 | 95 | | 480 | | | | | |
| 105 | 105 | | 540 | | | | | |
| 120 | 120 | | 600 | | | | | |
| 140 | 140 | | 720 | | | | | |
| 160 | 160 | | 840 | | | | | |
| D60_50071 | 50 | | 71 | 58 | 4 | | | 360 |
| 080 | | | 80 | | | | | 390 |
| 095 | | 95 | 480 | | | | | |
| 105 | | 105 | 540 | | | | | |
| 120 | | 120 | 600 | | | | | |
| 140 | | 140 | 720 | | | | | |
| 160 | | 160 | 840 | | | | | |
| D60_60085 | | 60 | 85 | | | 68 | 4 | 504 |
| 95 | | | 95 | | | | | 558 |
| 105 | 105 | | 612 | | | | | |
| 120 | 120 | | 720 | | | | | |
| 140 | 140 | | 828 | | | | | |

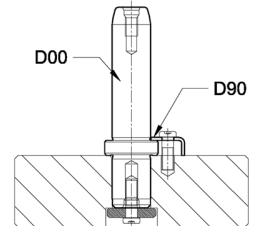
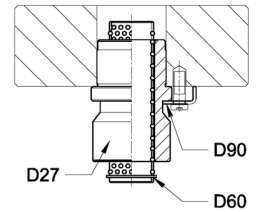
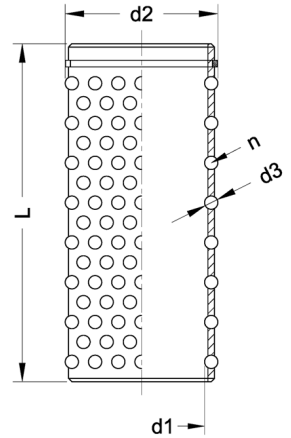

D60

Bilyalı Kafes / Ball Cage

Malzeme - Material : Ms58
 Bilya Malzemesi - Ball Material : 100Cr6 (1.3505)
 DIN 471
 DIN 5401



| Sipariş Kodu | d1 | L | d2 | d3 | n |
|--------------|----|-----|----|----|-----|
| D60_60160 | 60 | 160 | 68 | 4 | 972 |
| D60_63085 | 63 | 85 | 71 | 4 | 504 |
| 95 | | 95 | | | 558 |
| 105 | | 105 | | | 612 |
| 120 | | 120 | | | 720 |
| 140 | | 140 | | | 828 |
| 160 | | 160 | | | 972 |

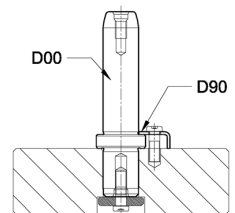
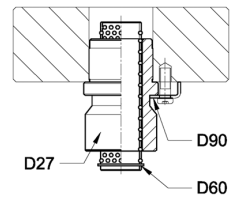
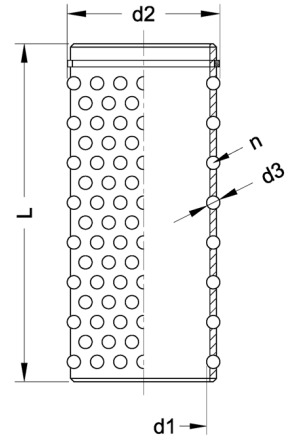

D60.01

Bilyalı Kafes Tutucusu / Helical Spring for Ball Cage Retention

Malzeme - Material : Yay Çeliği - Spring Steel

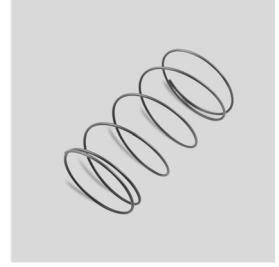

| d | L | Not / Note |
|----|---------|-------------------------|
| 19 | 040-140 | L 10 mm. aralıklarla |
| 20 | 040-140 | |
| 24 | 040-180 | |
| 25 | 040-180 | |
| 30 | 050-230 | |
| 32 | 050-230 | L 10 mm. gradation |
| 38 | 060-230 | |
| 40 | 060-230 | |
| 48 | 070-280 | |
| 50 | 070-280 | |
| 60 | 080-250 | |
| 63 | 080-250 | |

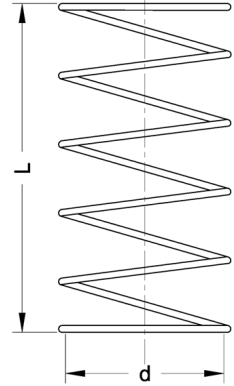
**Sipariş Kodu Örneği**

| | | |
|--------------|---|--------------|
| Spiral Yay | = | D60.01_ |
| Ø Kolon | = | 19 |
| Yay Boy | = | 040 |
| Sipariş Kodu | = | D60.01_19040 |

Order Code Example

| | | |
|----------------|---|--------------|
| Helical Spring | = | D60.01_ |
| Ø Pillar | = | 19 |
| Spring Length | = | 040 |
| Order Code | = | D60.01_19040 |

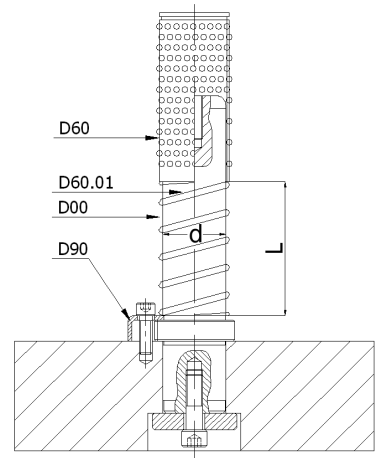

D30.01

Grafitli Burç / Oilless Guide Bush

Malzeme - Material : SAE 430B
 Sertlik - Hardness : HB≥180
 ≈DIN 9832



| Sipariş Kodu | FORD WDX1370 | NAAMS G61 | OPEL U2802-99(A) | Ø | | d2 | d3 | L1 | L2 |
|---------------|-----------------|--------------|---------------------|-----|-----|-----|-----|-----|----|
| | | | | d1 | L | | | | |
| D30.01_020040 | | | | 20 | 40 | 28 | 34 | 30 | 4 |
| 025040 | 11025 | 2540 | F33020019 | 25 | 40 | 32 | 40 | 30 | 4 |
| 030050 | | | | 30 | 50 | 40 | 50 | 40 | 4 |
| 032050 | 11032 | 3250 | F33020020 | 32 | 50 | 40 | 50 | 40 | 4 |
| 040063 | 11040 | 4063 | F33020021 | 40 | 63 | 50 | 63 | 50 | 5 |
| 050071 | 11050 | 5071 | F33020022 | 50 | 71 | 63 | 71 | 56 | 6 |
| 063080 | 11063 | 6300 | F33020023 | 63 | 80 | 80 | 90 | 63 | 8 |
| 080100 | 11080 | 8010 | F33020024 | 80 | 100 | 100 | 112 | 80 | 10 |
| 100125 | 11100 | 1012 | F33020025 | 100 | 125 | 125 | 140 | 106 | 12 |
| 125160 | 11125 | 1216 | F33020026 | 125 | 160 | 160 | 180 | 132 | 12 |

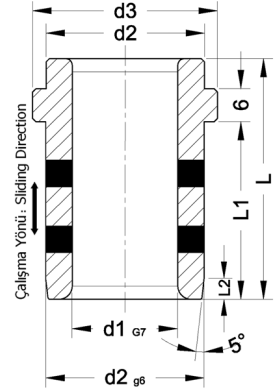

Not:
 Toleranssız ölçüler EN-22768 -1 standardına göre üretilir.
 Belirtilmeyen köşeler R=0,5

Note:
 All dimensions without tolerances as per EN 22768-1
 Corners indications R=0,5

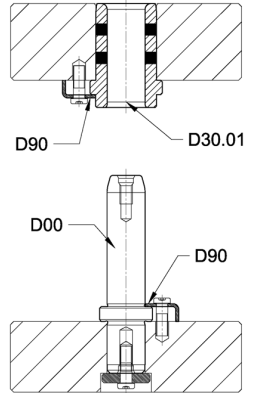

D30.02

Grafitli Burç / Oilless Guide Bush

Malzeme - Material : SAE 430B
Sertlik - Hardness : HB≥180



| Sipariş Kodu | FORD WDX1370 | FORD WSA 003 | Ø | | d2 | d3 | a |
|---------------|--------------|--------------|-----|-----|-----|-----|----|
| | | | d1 | L | | | |
| D30.02_020035 | 05020 | 11020 | 20 | 35 | 28 | 36 | 8 |
| 025040 | | | 25 | 40 | 32 | 40 | 8 |
| 030055 | | | 30 | 55 | 40 | 50 | 8 |
| 032055 | 05032 | | 32 | 55 | 40 | 50 | 8 |
| 040070 | 05040 | | 40 | 70 | 50 | 60 | 8 |
| 042070 | 05042 | 11042 | 42 | 70 | 50 | 60 | 8 |
| 050075 | 05050 | | 50 | 75 | 63 | 75 | 12 |
| 052075 | 05052 | 11052 | 52 | 75 | 63 | 75 | 12 |
| 063080 | 05063 | | 63 | 80 | 80 | 90 | 12 |
| 080100 | 05080 | | 80 | 100 | 100 | 110 | 12 |
| 100125 | 05100 | | 100 | 125 | 125 | 135 | 12 |

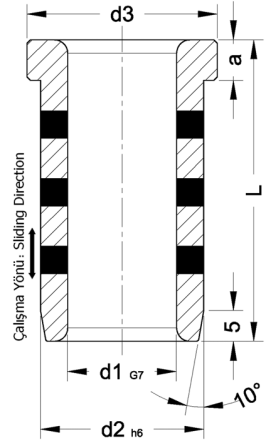

Not:
Toleranssız ölçüler EN-22768 -1 standardına göre üretilir.
Belirtilmeyen köşeler R=0,5

Note:
All dimensions without tolerances as per EN 22768-1
Corners indications R=0,5

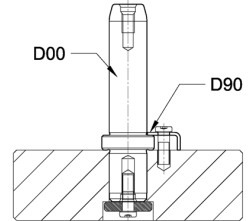
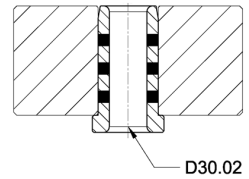

D30.03

Grafitli Burç / Oilless Guide Bush - AFNOR

Malzeme - Material : SAE 430B
Sertlik - Hardness : HB \geq 180



| Sipariş Kodu | PSA MABEC CODE | RENAULT MABEC CODE | Ø | | d2 | d3 | a | L2 |
|---------------|-------------------|-----------------------|-----|-----|-----|-----|----|----|
| | | | d1 | L | | | | |
| D30.03_025040 | | | 25 | 40 | 35 | 40 | 5 | 5 |
| 032050 | | | 32 | 50 | 44 | 50 | 6 | 5 |
| 040063 | X345 274 670 | M764 539 401 | 40 | 63 | 52 | 60 | 8 | 8 |
| 050080 | X345 281 970 | M764 544 501 | 50 | 80 | 63 | 71 | 10 | 8 |
| 063100 | X345 287 270 | M764 549 501 | 63 | 100 | 80 | 90 | 12 | 10 |
| 080125 | X345 292 370 | M764 554 601 | 80 | 125 | 100 | 112 | 16 | 10 |
| 100160 | | X345 298 500 | 100 | 160 | 125 | 140 | 20 | 10 |

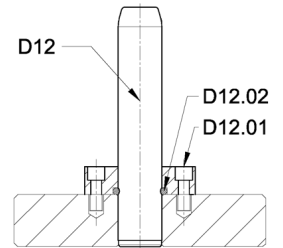
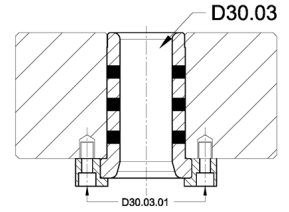
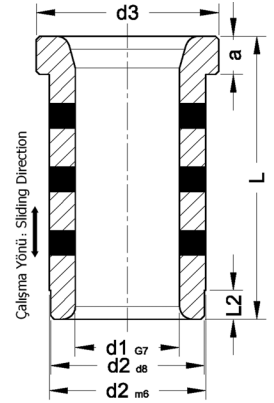

D30.04

Grafitli Burç / Oilless Guide Bush

Malzeme - Material : SAE 430B
Sertlik - Hardness : HB≥180



| Sipariş Kodu | Ø d1 | L | d2 | L1 |
|-----------------|---------|----|----|----|
| D30.04_20015028 | 20 | 15 | 28 | 4 |
| 016028 | | 16 | 28 | |
| 016030 | | 16 | 30 | |
| 020028 | | 20 | 28 | |
| 020030 | | 20 | 30 | |
| 025028 | | 25 | 28 | |
| 025030 | | 25 | 30 | |
| 030028 | | 30 | 28 | |
| 030030 | | 30 | 30 | |
| 035028 | | 35 | 28 | |
| 035030 | | 35 | 30 | |
| 037028 | | 37 | 28 | |
| 040026 | | 40 | 26 | |
| 040028 | | 40 | 28 | |
| 040030 | | 40 | 30 | |
| 050028 | 50 | 28 | | |
| D30.04_25016033 | 25 | 16 | 33 | 4 |
| 016035 | | 16 | 35 | |
| 020033 | | 20 | 33 | |
| 020035 | | 20 | 35 | |
| 025033 | | 25 | 33 | |
| 025035 | | 25 | 35 | |
| 030033 | | 30 | 33 | |
| 030035 | | 30 | 35 | |
| 035033 | | 35 | 33 | |
| 035035 | | 35 | 35 | |
| 040033 | | 40 | 33 | |
| 040035 | | 40 | 35 | |
| 047033 | | 47 | 33 | |
| 050032 | | 50 | 32 | |
| 050033 | | 50 | 33 | |
| 050035 | 50 | 35 | | |
| 060033 | 60 | 33 | | |
| D30.04_30020038 | 30 | 20 | 38 | 4 |
| 020040 | | 20 | 40 | |
| 025038 | | 25 | 38 | |
| 025040 | | 25 | 40 | |
| 030038 | | 30 | 38 | |
| 030040 | | 30 | 40 | |
| 035038 | | 35 | 38 | |
| 035040 | | 35 | 40 | |
| 040038 | | 40 | 38 | |

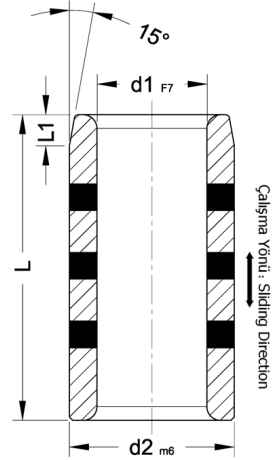

D30.04

Grafitli Burç / Oilless Guide Bush

Malzeme - Material : SAE 430B
Sertlik - Hardness : HB≥180



| Sipariş Kodu | Ø d1 | L | d2 | L1 |
|-----------------|---------|----|----|----|
| D30.04_30040040 | 30 | 40 | 40 | 4 |
| 050038 | | 50 | 38 | |
| 050040 | | 50 | 40 | |
| 060038 | | 60 | 38 | |
| 060040 | | 60 | 40 | |
| 060042 | | 60 | 42 | |
| D30.04_35020045 | 35 | 20 | 45 | 4 |
| 025044 | | 25 | 44 | |
| 025045 | | 25 | 45 | |
| 030044 | | 30 | 44 | |
| 030045 | | 30 | 45 | |
| 035044 | | 35 | 44 | |
| 035045 | | 35 | 45 | |
| 040044 | | 40 | 44 | |
| 040045 | | 40 | 45 | |
| 050044 | | 50 | 44 | |
| 050045 | | 50 | 45 | |
| 060044 | | 60 | 44 | |
| 060045 | | 60 | 45 | |
| D30.04_40020050 | | 40 | 20 | |
| 025050 | 25 | | 50 | |
| 025055 | 25 | | 55 | |
| 030050 | 30 | | 50 | |
| 030055 | 30 | | 55 | |
| 035050 | 35 | | 50 | |
| 035055 | 35 | | 55 | |
| 040050 | 40 | | 50 | |
| 040055 | 40 | | 55 | |
| 050050 | 50 | | 50 | |
| 050055 | 50 | | 55 | |
| 060050 | 60 | | 50 | |
| 060055 | 60 | | 55 | |
| 070050 | 70 | | 50 | |
| 077050 | 77 | 50 | | |
| 080050 | 80 | 50 | | |
| D30.04_50030060 | 50 | 30 | 60 | 4 |
| 030062 | | 30 | 62 | |
| 030065 | | 30 | 65 | |
| 035060 | | 35 | 60 | |
| 035062 | | 35 | 62 | |
| 040060 | | 40 | 60 | |
| 040062 | 40 | 62 | | |

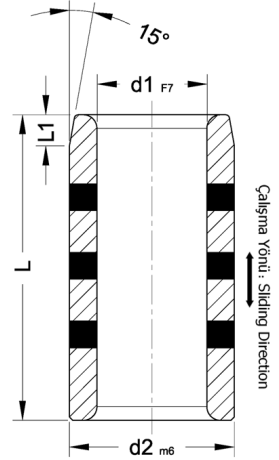

D30.04

Grafitli Burç / Oilless Guide Bush

Malzeme - Material : SAE 430B
Sertlik - Hardness : HB≥180



| Sipariş Kodu | Ø d1 | L | d2 | L1 |
|-----------------|---------|-----|----|----|
| D30.04_50040065 | 50 | 40 | 65 | 4 |
| 050060 | | 50 | 60 | |
| 050062 | | 50 | 62 | |
| 050065 | | 50 | 65 | |
| 060060 | | 60 | 60 | |
| 060062 | | 60 | 62 | |
| 060065 | | 60 | 65 | |
| 070060 | | 70 | 60 | |
| 070062 | | 70 | 62 | |
| 070065 | | 70 | 65 | |
| 080060 | | 80 | 60 | |
| 080065 | | 80 | 65 | |
| 095060 | | 95 | 60 | |
| 100065 | | 100 | 65 | |
| D30.04_63030074 | 63 | 30 | 74 | 4 |
| 030075 | | 30 | 75 | |
| 035074 | | 35 | 74 | |
| 035075 | | 35 | 75 | |
| 040074 | | 40 | 74 | |
| 040075 | | 40 | 75 | |
| 050074 | | 50 | 74 | |
| 050075 | | 50 | 75 | |
| 060074 | | 60 | 74 | |
| 060075 | | 60 | 75 | |
| 070074 | | 70 | 74 | |
| 070075 | | 70 | 75 | |
| 080074 | | 80 | 74 | |
| 080075 | | 80 | 75 | |
| 100075 | 100 | 75 | | |

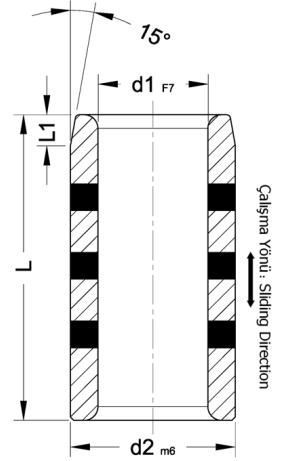

D30.05

Grafitli Burç / Oilless Guide Bush

Malzeme - Material : SAE 430B
Sertlik - Hardness : HB≥180



| Sipariş Kodu | d1 | L | d2 | d3 | a | L4 |
|--------------|----|-----|----|----|----|----|
| D30.05_20017 | 20 | 17 | 26 | 31 | 6 | 2 |
| 022 | | 22 | | | | |
| 027 | | 27 | | | | |
| 036 | | 36 | | | | |
| 046 | | 46 | | | | |
| 056 | | 56 | | | | |
| 066 | | 66 | | | | |
| 076 | | 76 | | | | |
| D30.05_25046 | 25 | 46 | 32 | 38 | 6 | 3 |
| 056 | | 56 | | | | |
| 066 | | 66 | | | | |
| 076 | | 76 | | | | |
| 086 | | 86 | | | | |
| D30.05_30027 | 30 | 27 | 42 | 47 | 6 | 4 |
| 036 | | 36 | | | | |
| 046 | | 46 | | | | |
| 056 | | 56 | | | | |
| 066 | | 66 | | | | |
| 076 | | 76 | | | | |
| 086 | | 86 | | | | |
| 096 | | 96 | | | | |
| 116 | | 116 | | | | |
| D30.05_40046 | 40 | 46 | 54 | 60 | 10 | 5 |
| 056 | | 56 | | | | |
| 066 | | 66 | | | | |
| 076 | | 76 | | | | |
| 086 | | 86 | | | | |
| 096 | | 96 | | | | |
| 116 | | 116 | | | | |
| 136 | | 136 | | | | |
| 156 | | 156 | | | | |
| D30.05_50076 | 50 | 76 | 66 | 72 | 10 | 5 |
| 086 | | 86 | | | | |
| 096 | | 96 | | | | |
| 116 | | 116 | | | | |
| 136 | | 136 | | | | |
| 156 | | 156 | | | | |
| 196 | | 196 | | | | |

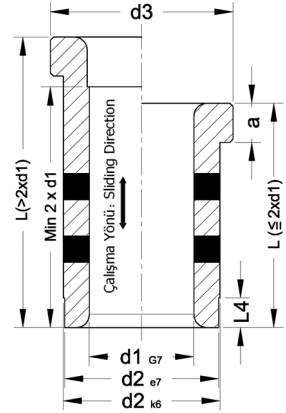

D30.05

Grafitli Burç / Oilless Guide Bush

Malzeme - Material : SAE 430B
Sertlik - Hardness : HB≥180



| Sipariş Kodu | d1 | L | d2 | d3 | a | L4 |
|--------------|----|-----|----|----|----|----|
| D30.05_60096 | 60 | 96 | 80 | 86 | 20 | 5 |
| 116 | | 116 | | | | |
| 136 | | 136 | | | | |
| 156 | | 156 | | | | |
| 196 | | 196 | | | | |
| D30.05_63096 | 63 | 96 | 80 | 86 | 20 | 5 |
| 116 | | 116 | | | | |
| 136 | | 136 | | | | |
| 156 | | 156 | | | | |
| 196 | | 196 | | | | |

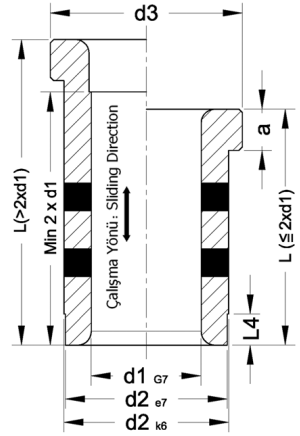

D30.06

Grafitli Burç / Oilless Guide Bush

Malzeme - Material : SAE 430B
Sertlik - Hardness : HB≥180



| Sipariş Kodu | BMW CODE B2 2933 1 | PSA MABEC CODE | Ø | d1 | L | d2 | d3 | D6 | L1 | a | L4 |
|---------------|-----------------------|-------------------|---|-----|-----|-----|-----|-----|-----|-----|------|
| D30.06_025040 | 2168699 | | | 25 | 40 | 32 | 40 | 58 | 30 | 6.3 | 3 |
| 032050 | 2168700 | | | 32 | 50 | 40 | 50 | 66 | 40 | 6.3 | 4 |
| 040063 | 2168701 | | | 40 | 63 | 50 | 63 | 79 | 50 | 6.3 | 5 |
| 050071 | 2168702 | | | 50 | 71 | 63 | 71 | 89 | 56 | 6.3 | 6.3 |
| 063080 | 2168703 | | | 63 | 80 | 80 | 90 | 123 | 63 | 10 | 8 |
| 080100 | 2168704 | | | 80 | 100 | 100 | 112 | 143 | 80 | 10 | 10 |
| 100125 | 2168705 | Z000499644 | | 100 | 125 | 125 | 140 | 168 | 106 | 10 | 12.5 |
| 125160 | 2168706 | Z000499646 | | 125 | 160 | 160 | 180 | 203 | 132 | 10 | 16 |
| 160200 | 2168707 | | | 160 | 200 | 200 | 220 | 243 | 170 | 10 | 16 |

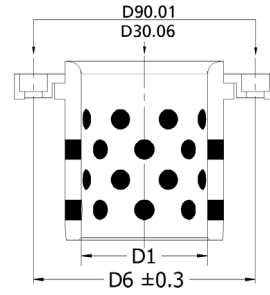
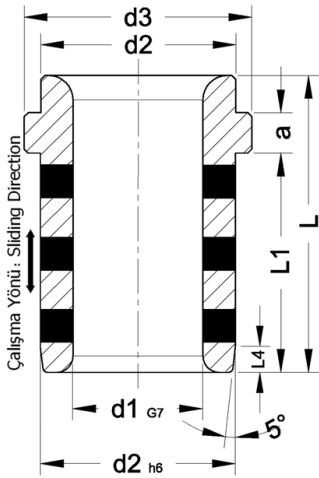

D80.01

Grafitli Sürtünme Plakası
Wear Plate With Graphite Insert
Malzeme - Material : SAE 430B
Sertlik - Hardness : HB≥180
ISO 9183-1



| Sipariş Kodu | VW/AUDI 39D863 | FORD WDX 13-70 | OPEL 3425 | W | L | w1 | L1 | L2 | d1 | d | t | | |
|---------------|-------------------|-------------------|--------------|-----|-----|----|-----|-----|----|------|----|------|----|
| D80.01_050080 | 12 | | | 50 | 80 | 25 | 25 | 30 | 15 | 9 | 9 | | |
| 100 | 13 | 02050100-Y | F33 04 0000 | | 100 | | | 50 | | | | 13.5 | 13 |
| 125 | 14 | | F33 04 0001 | | 125 | | | 75 | | | | | |
| 160 | 15 | 02050160-Y | F33 04 0002 | | 160 | | | 110 | | | | | |
| 200 | 16 | 02050200-Y | F33 04 0003 | | 200 | | | 150 | | | | | |
| D80.01_080080 | 22 | | | 80 | 80 | 40 | 25 | 30 | 20 | 13.5 | 13 | | |
| 100 | 23 | 02080100-Y | F33 04 0004 | | 100 | | | 50 | | | | | |
| 125 | 24 | | F33 04 0005 | | 125 | | | 75 | | | | | |
| 160 | 25 | 02080160-Y | F33 04 0006 | | 160 | | | 110 | | | | | |
| 200 | 26 | 02080200-Y | F33 04 0007 | | 200 | | | 150 | | | | | |
| 250 | | 02080250-Y | | | 250 | | 170 | 40 | | | | | |
| 315 | | 02080315-Y | | | 315 | | 235 | | | | | | |
| D80.01_100100 | 33 | 02100100-Y | F33 04 0010 | 100 | 100 | 50 | 25 | 50 | 20 | 13.5 | 13 | | |
| 125 | 34 | 02100125-Y | F33 04 0011 | | 125 | | | 75 | | | | | |
| 160 | 35 | 02100160-Y | F33 04 0012 | | 160 | | | 110 | | | | | |
| 200 | 36 | 02100200-Y | F33 04 0013 | | 200 | | | 150 | | | | | |
| 250 | | 02100250-Y | | | 250 | | | 170 | | | | 40 | |
| 315 | | 02100315-Y | | | 315 | | 235 | | | | | | |

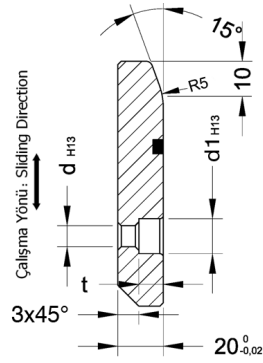
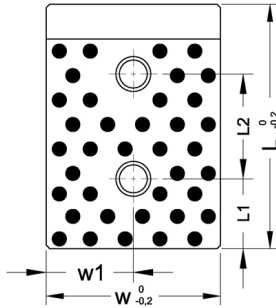

D80.02

Grafitli Sürtünme Plakası
Wear Plate With Graphite Insert

Malzeme - Material : SAE 430B
Sertlik - Hardness : HB≥180



| Sipariş Kodu | VW/AUDI 39D863 | FORD WDX | OPEL 3425 | W | L | w1 | w2 | w3 | L1 | L2 | d1 | d | t | Form |
|---------------|-------------------|-----------------|--------------|-----|-----|----|------|------|----|-----|----|------|----|------|
| D80.02_080050 | 21 | | | 80 | 50 | 25 | 30 | | 25 | | 15 | 9 | 9 | A |
| D80.02_100050 | 31 | 1370 02100050-Y | F33 04 0008 | 100 | 50 | 25 | 50 | | 25 | | 20 | 13.5 | 13 | A |
| 080 | 32 | | F33 04 0009 | 100 | 80 | | | | 40 | | | | | |
| D80.02_125050 | 41 | | | 125 | 50 | 25 | 75 | | 25 | | 20 | 13.5 | 13 | A |
| 080 | 42 | | F33 04 0014 | 125 | 80 | | | | 40 | | | | | |
| 100 | 43 | 1370 02125100-Y | F33 04 0015 | 125 | 100 | | 37.5 | 37.5 | 25 | 50 | | | | C |
| 125 | 44 | | F33 04 0016 | 125 | 125 | | | | | 75 | | | | |
| 160 | 45 | 1370 02125160-Y | F33 04 0017 | 125 | 160 | | | | | 110 | | | | |
| 200 | 46 | 1370 02125200-Y | | 125 | 200 | | | | | 150 | | | | |
| 250 | | 1370 02125250-Y | | 125 | 250 | | | | 40 | 170 | | | | |
| 315 | | 1370 02125315-Y | | 125 | 315 | | | | | 235 | | | | |
| D80.02_160050 | 51 | | | 160 | 50 | 25 | 110 | | 25 | | 20 | 13.5 | 13 | A |
| 080 | 52 | | | 160 | 80 | | | | 40 | | | | | |
| 100 | 53 | 1370 02160100-Y | F33 04 0018 | 160 | 100 | | 55 | 55 | 25 | 50 | | | | C |
| 125 | 54 | | F33 04 0019 | 160 | 125 | | | | | 75 | | | | |
| 160 | 55 | 1370 02160160-Y | F33 04 0020 | 160 | 160 | | | | | 110 | | | | |
| 200 | 56 | 1370 02160200-Y | | 160 | 200 | | | | | 150 | | | | |
| 250 | | 1370 02160250-Y | | 160 | 250 | | 110 | | 40 | 170 | | | | B |
| 315 | | 1370 02160315-Y | | 160 | 315 | | | | | 235 | | | | |
| 250.01 | | 1365 01160250-Y | | 160 | 250 | | 55 | 55 | | 170 | | | | C |
| 315.01 | | 1365 01160315-Y | | 160 | 315 | | | | | 235 | | | | |

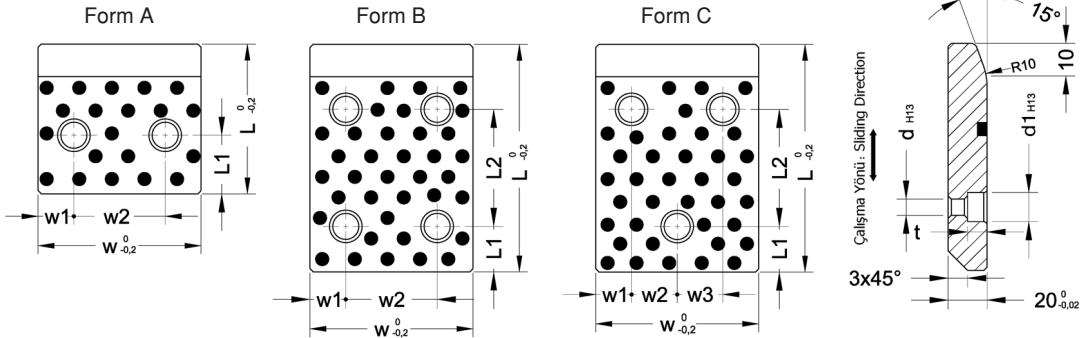

D80.03

Grafitli Sürtünme Plakası
Wear Plate With Graphite Insert

Malzeme - Material : SAE 430B
Sertlik - Hardness : HB≥180
ISO 9183-2



| Sipariş Kodu | PSA Mabec Code | RENAULT Mabec Code | W | L | e | e1 | e2 | e3 | Form |
|---------------|----------------|--------------------|-----|-----|----|-----|----|----|------|
| D80.03_070100 | Z000 166 214 | R100 092 843 | 70 | 100 | 50 | 20 | | | A |
| 150 | Z000 166 216 | R100 092 844 | | 150 | | 10 | 20 | | B |
| 200 | Z000 166 221 | R100 092 845 | | 200 | | 20 | | | D |
| D80.03_100150 | Z000 166 217 | R100 092 883 | 100 | 150 | 25 | 50 | | 50 | C |
| 200 | Z000 166 222 | R100 092 884 | | 200 | | 50 | | | D |
| 250 | Z000 166 225 | R100 092 885 | | 250 | | 50 | | | E |
| D80.03_150200 | Z000 166 223 | R100 092 890 | 150 | 200 | 50 | 100 | | | D |
| 250 | Z000 166 226 | R100 092 893 | | 250 | | 100 | | | E |

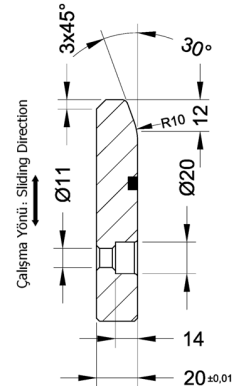
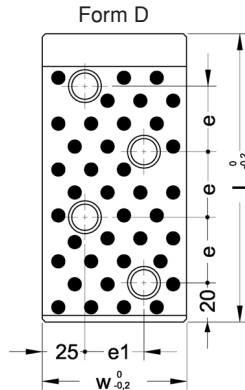
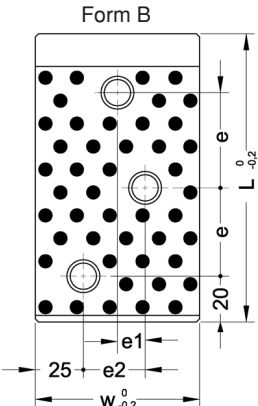
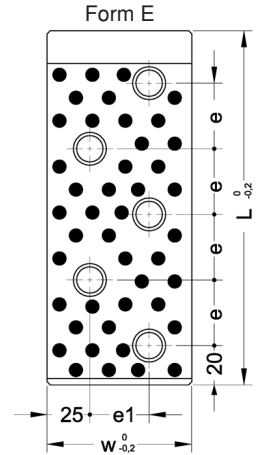
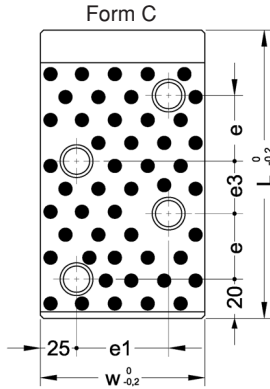
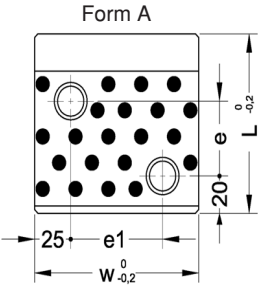

D80.03

Grafitli Sürtünme Plakası
Wear Plate With Graphite Insert

Malzeme - Material : SAE 430B
Sertlik - Hardness : HB≥180
ISO 9183-2



| Sipariş Kodu | PSA Mabec Code | RENAULT Mabec Code | W | L | e | e1 | e2 | e3 | e4 | Form |
|---------------|----------------|--------------------|-----|-----|----|-----|----|----|----|------|
| D80.03_100100 | Z000 166 215 | R100 092 846 | 100 | 100 | | 30 | 20 | | 25 | I |
| 300 | Z000 166 227 | R100 092 886 | | 300 | 50 | 50 | | | | F |
| D80.03_150100 | Z000 166 218 | R100 092 887 | 150 | 100 | | 25 | 50 | 50 | | G |
| 150 | Z000 166 219 | R100 092 888 | | 150 | | 25 | 50 | | | H |
| 300 | Z000 166 228 | R100 092 894 | | 300 | 50 | 100 | | | | F |
| D80.03_200100 | Z000 166 224 | R100 092 895 | 200 | 100 | | 50 | 50 | 50 | | G |

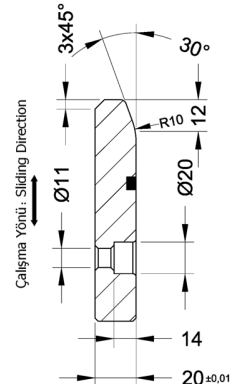
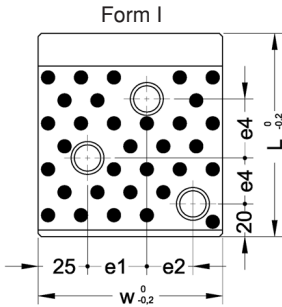
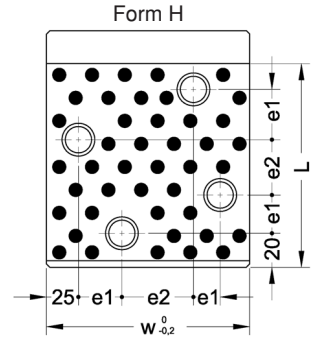
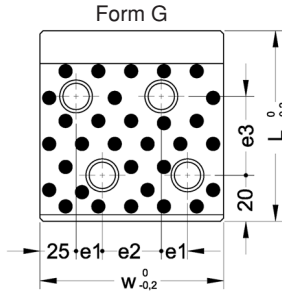
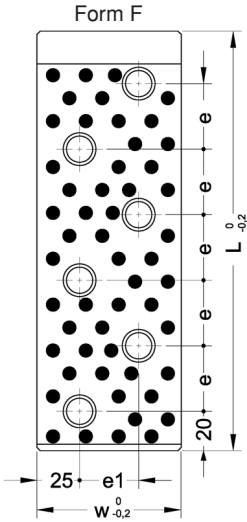

D80.04

Grafitli Sürtünme Plakası
Wear Plate With Graphite Insert

Malzeme - Material : SAE 430B
Sertlik - Hardness : HB≥180



| Sipariş Kodu | FORD CODE WDX1362 | W | L | A | B | C | D | E | F | G | Form | |
|---------------|----------------------|-----|-----|----|---|-----|----|---|---|-----|------|---|
| D80.04_050100 | 02050100-Y | 50 | 100 | 25 | | 25 | 30 | | | 60 | A | |
| 150 | 02050150-Y | | 150 | | | | 30 | | | 110 | A | |
| 200 | 02050200-Y | | 200 | | | | 40 | | | 160 | A | |
| D80.04_080100 | 02080100-Y | 80 | 100 | 20 | | 60 | 30 | | | 60 | A | |
| 150 | 02080150-Y | | 150 | | | | 30 | | | 110 | A | |
| 200 | 02080200-Y | | 200 | | | | 40 | | | 160 | A | |
| 250 | 02080250-Y | | 250 | | | | 40 | | | 210 | A | |
| 315 | 02080315-Y | | 315 | | | | 40 | | | 250 | 275 | B |
| | | | | | | | | | | 40 | 40 | |
| D80.04_100100 | 02100100-Y | 100 | 100 | 22 | | 78 | 30 | | | 60 | A | |
| 150 | 02100150-Y | | 150 | | | | 30 | | | 110 | A | |
| 200 | 02100200-Y | | 200 | | | | 40 | | | 135 | 160 | B |
| 250 | 02100250-Y | | 250 | | | | 40 | | | 185 | 210 | B |
| 315 | 02100315-Y | | 315 | | | | 40 | | | 250 | 275 | B |
| D80.04_125100 | 02125100-Y | 125 | 100 | 25 | | 100 | 30 | | | 60 | A | |
| 150 | 02125150-Y | | 150 | | | | 30 | | | 110 | A | |
| 200 | 02125200-Y | | 200 | | | | 40 | | | 135 | 160 | B |
| 250 | 02125250-Y | | 250 | | | | 40 | | | 185 | 210 | B |
| 315 | 02125315-Y | | 315 | | | | 40 | | | 250 | 275 | C |
| D80.04_160100 | 02160100-Y | 160 | 100 | 30 | | 130 | 30 | | | 60 | A | |
| 150 | 02160150-Y | | 150 | | | | 30 | | | 110 | A | |
| 200 | 02160200-Y | | 200 | | | | 40 | | | 135 | 160 | B |
| 250 | 02160250-Y | | 250 | | | | 40 | | | 185 | 210 | C |
| 315 | 02160315-Y | | 315 | | | | 40 | | | 250 | 275 | C |

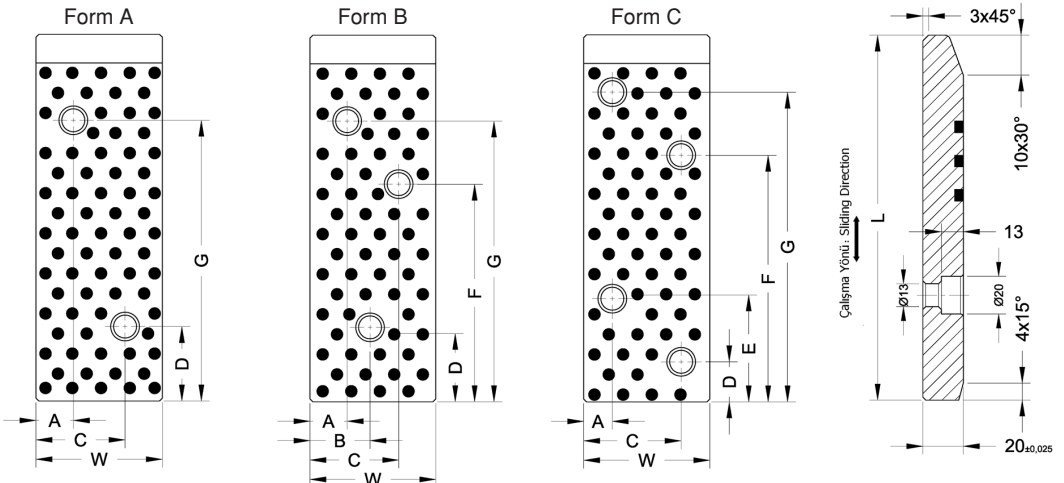

D80.15

Çelik Sürtünme Plakası
Sliding Pads
CNOMO

Malzeme - Material : Çelik (Steel)
Sertlik - Hardness : 62±2 HRC

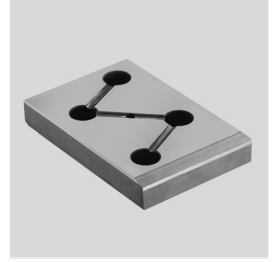

| Sipariş Kodu | PSA Mabec Code | RENAULT Mabec Code | W | L | e1 | e2 | e3 | e4 | e5 | e6 | e7 | e8 | e9 | Form |
|---------------|----------------|--------------------|-----|-----|-----|----|----|----|-----|-----|-----|----|----|------|
| D80.15_070100 | Z000166213 | P446625854 | 70 | 100 | 20 | | | 70 | | | | | 10 | A |
| 150 | P446626558 | P446626558 | | 150 | 10 | 10 | | | 120 | | | | 10 | B |
| 200 | P446627059 | P446627059 | | 200 | 20 | | | | | 170 | | | 10 | D |
| D80.15_100150 | P446626559 | P446626559 | 100 | 150 | 50 | | | 45 | 95 | 120 | | | 25 | C |
| 200 | P446627060 | P446627060 | | 200 | | | | 70 | 120 | 170 | | | 25 | D |
| 250 | P446627454 | P446627454 | | 250 | | | | | | | 220 | | 25 | E |
| D80.15_150200 | P446627061 | P446627061 | 150 | 200 | 100 | | | 70 | 120 | 170 | | | 50 | D |
| 250 | P446627455 | P446627455 | | 250 | 100 | | | | | | 220 | | 50 | E |

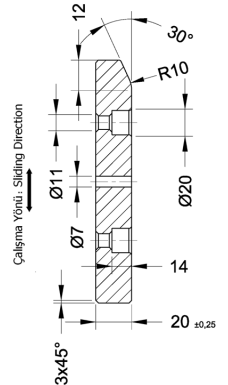
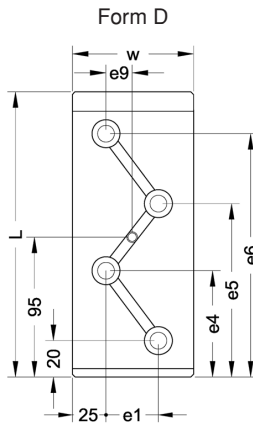
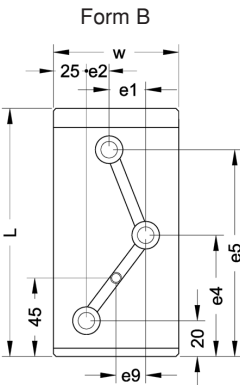
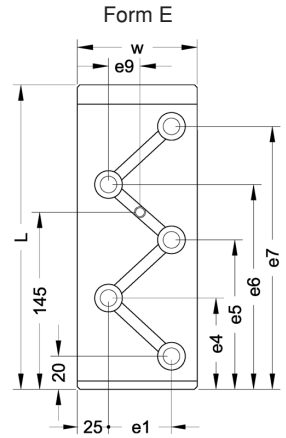
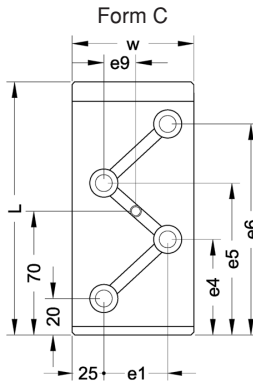
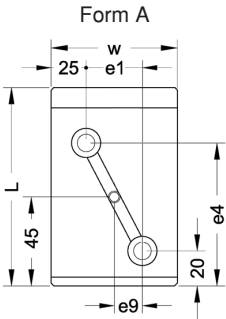

D80.15

Çelik Sürtünme Plakası
Sliding Pads
CNOMO

Malzeme - Material : Çelik (Steel)
Sertlik - Hardness : 62±2 HRC

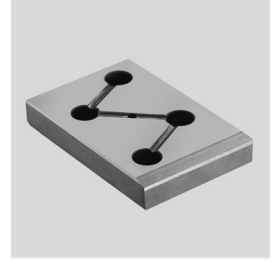

| Sipariş Kodu | PSA Mabec Code | RENAULT Mabec Code | W | L | e1 | e2 | e3 | e4 | e5 | e6 | e7 | e8 | e9 | Form |
|---------------|----------------|--------------------|-----|-----|-----|-----|-----|----|-----|-----|-----|-----|----|------|
| D80.15_100100 | P446625855 | P446625855 | 100 | 100 | 30 | 50 | | 45 | 70 | | | | 25 | I |
| 300 | P446627754 | P446627754 | | 300 | 50 | | | 70 | 120 | 170 | 220 | 270 | 25 | F |
| D80.15_150100 | P446626560 | P446626560 | 150 | 100 | 25 | 75 | 100 | 70 | | | | | 50 | G |
| 150 | P446626561 | P446626561 | | 150 | | | | 45 | 95 | 120 | | | 50 | H |
| 300 | P446627755 | P446627755 | | 300 | 100 | | | 70 | 120 | 170 | 220 | 270 | 50 | F |
| D80.15_200100 | Z000166220 | P446627062 | 200 | 100 | 50 | 100 | 150 | 70 | | | | | 75 | G |

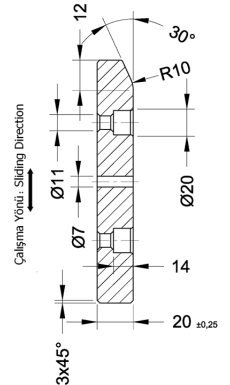
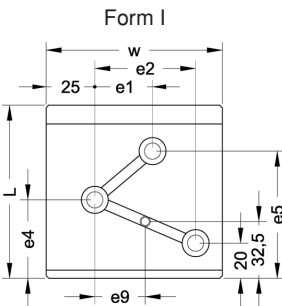
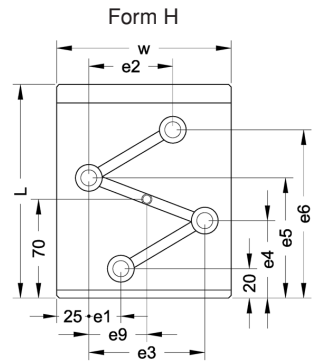
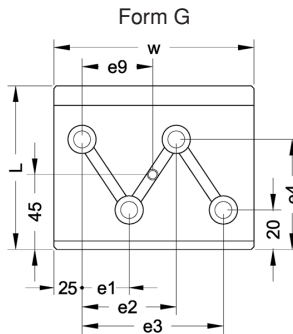
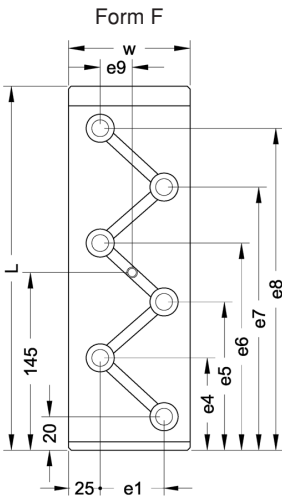

D88

Düz Kam
Horizontal Cam Slide Unit

No Parça Adı / Description

Ad. Malzeme
Qty Material

Not
Note

- | | | |
|------------------------------------|---------------------------|---|
| 1 Üst Gövde / Upper Body | 1 SO#50F | Grafittli Yüzey / Surface with Graphite |
| 2 Alt Gövde / Lower Body | 1 SO#50F | |
| 3 Sürücü / Driver | 1 SO#50F | |
| 4 Arka Kapak / Stoper Plate | 1 Çelik / Steel 55-60 HRC | |
| 5 Üst Yan Kapak / Upper Plate | 2 Çelik / Steel | |
| 6 Yan Klavuz Kol / Return Follower | 1 Çelik / Steel 55-60 HRC | |



| Sipariş Kodu | Yay Ölçüleri Spring Size | | İlk Durum Initial | | Final | | Zimba Alanı Space for Punch B x H (mm) | Maksimum Çalışma Gücü Max. Working Force (kN) | Kurs Stroke (mm) | Ağırlık Weight (Kg) |
|--------------|-----------------------------|------------------------------------|---------------------------|---------------------|---------------------------|---------------------|---|--|------------------------|---------------------------|
| | Ø Yay O.D. (mm) | Serbest Boy Free Length (mm) | Uzunluk Length (mm) | Yükleme Load (N) | Uzunluk Length (mm) | Yükleme Load (N) | | | | |
| D88_05225 | 20 | 70 | 62 | 150 | 37 | 600 | 52x65 | 10 | 25 | 8 |
| D88_05240 | 20 | 100 | 92 | 100 | 52 | 610 | 52x65 | 10 | 40 | 8 |
| D88_05260 | 20 | 150 | 137 | 110 | 77 | 620 | 52x65 | 10 | 60 | 11 |
| D88_06540 | 22 | 100 | 92 | 130 | 52 | 770 | 65x70 | 18 | 40 | 15 |
| D88_06560 | 22 | 150 | 137 | 130 | 77 | 770 | 65x70 | 18 | 60 | 19 |
| D88_10040 | 27 | 100 | 92 | 190 | 52 | 1150 | 100x100 | 30 | 40 | 32 |
| D88_10060 | 27 | 150 | 137 | 210 | 77 | 1170 | 100x100 | 30 | 60 | 33 |
| D88_10080 | 30 | 200 | 188 | 173 | 108 | 1325 | 100x100 | 30 | 80 | 38 |
| D88_15040 | 35 | 100 | 92 | 320 | 52 | 1880 | 150x100 | 60 | 40 | 53 |
| D88_15060 | 35 | 150 | 137 | 340 | 77 | 1900 | 150x100 | 60 | 60 | 57 |
| D88_20040 | 35 | 100 | 92 | 470 | 52 | 2820 | 200x110 | 80 | 40 | 71 |
| D88_20060 | 35 | 150 | 137 | 510 | 77 | 2850 | 200x110 | 80 | 60 | 76 |
| D88_25040 | 40 | 100 | 92 | 620 | 52 | 3690 | 250x130 | 100 | 40 | 97 |
| D88_25060 | 40 | 150 | 137 | 660 | 77 | 3720 | 250x130 | 100 | 60 | 105 |
| D88_30040 | 40 | 100 | 92 | 620 | 52 | 3690 | 300x130 | 130 | 40 | 113 |
| D88_30060 | 40 | 150 | 137 | 660 | 77 | 3720 | 300x130 | 130 | 60 | 120 |
| D88_40060 | 60 | 150 | 148 | 156 | 88 | 4760 | 400x150 | 140 | 60 | 202 |
| D88_50060 | 60 | 150 | 148 | 310 | 88 | 9520 | 500x150 | 140 | 60 | 236 |
| D88_60060 | 60 | 150 | 148 | 310 | 88 | 9520 | 600x150 | 140 | 60 | 269 |

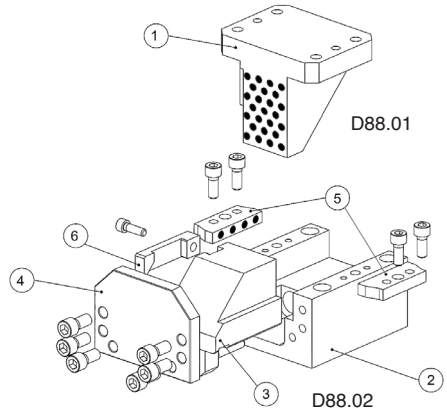
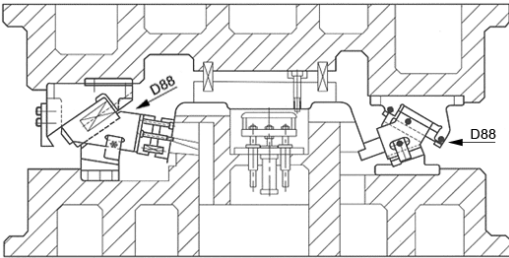

Uçan ve Açılı Kamlar

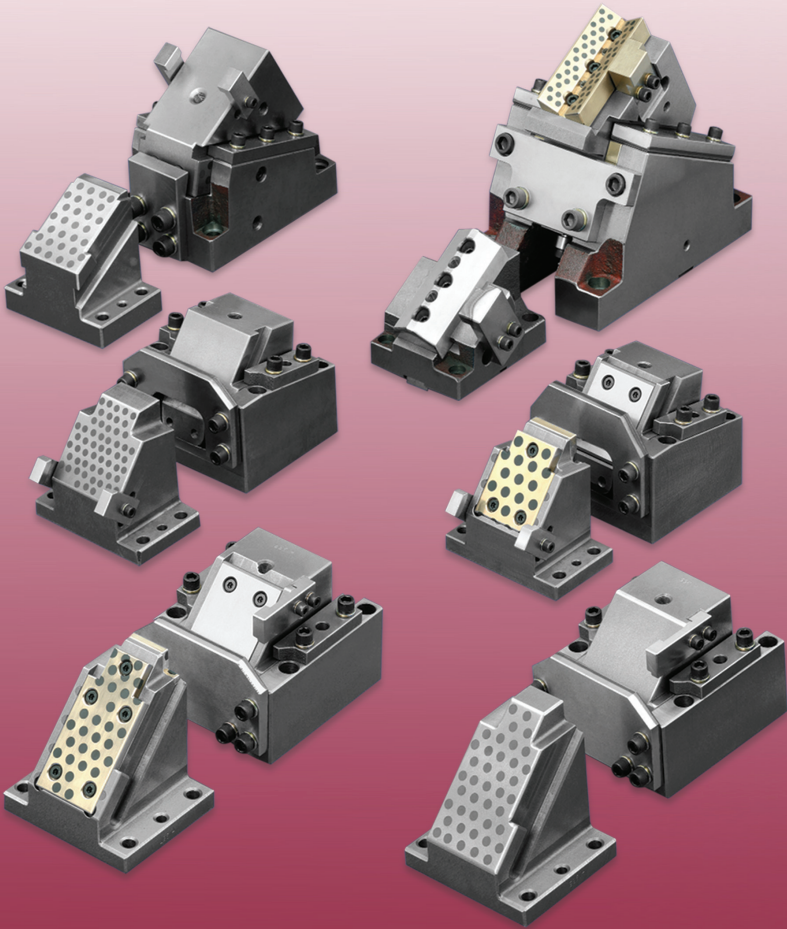

Uçan ve Açılı Kamlar için bayilerimizden teklif isteyiniz...

Dikkat / Attention



Gaz dolumunda sadece nitrojen (N₂) kullanınız
When gas charging the cylinder, only use nitrogen (N₂)

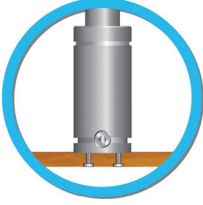

Gazlı yayı civata veya bağlama pabucuyla monte ediniz
Install the gas spring with the bolt or the flange under the bottom part



Gövde veya pime darbe uygulamayınız
Avoid any mechanical change or impact on the cylinder and rod



Yağlama yapmayınız
Don't use any lubricants or oils to the gas spring

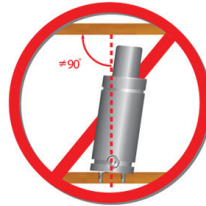
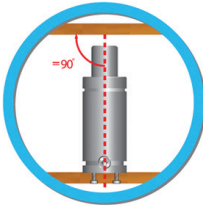

Plakaya dik monte ediniz
Positioning the gas spring is perpendicular in the plate

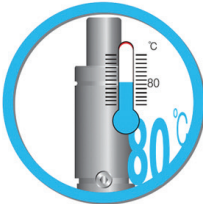

Çalışma esnasında gazlı yayın ısısı 80°C'nin altında olmalıdır
Proper temperature of gas spring during operation is below 80°C

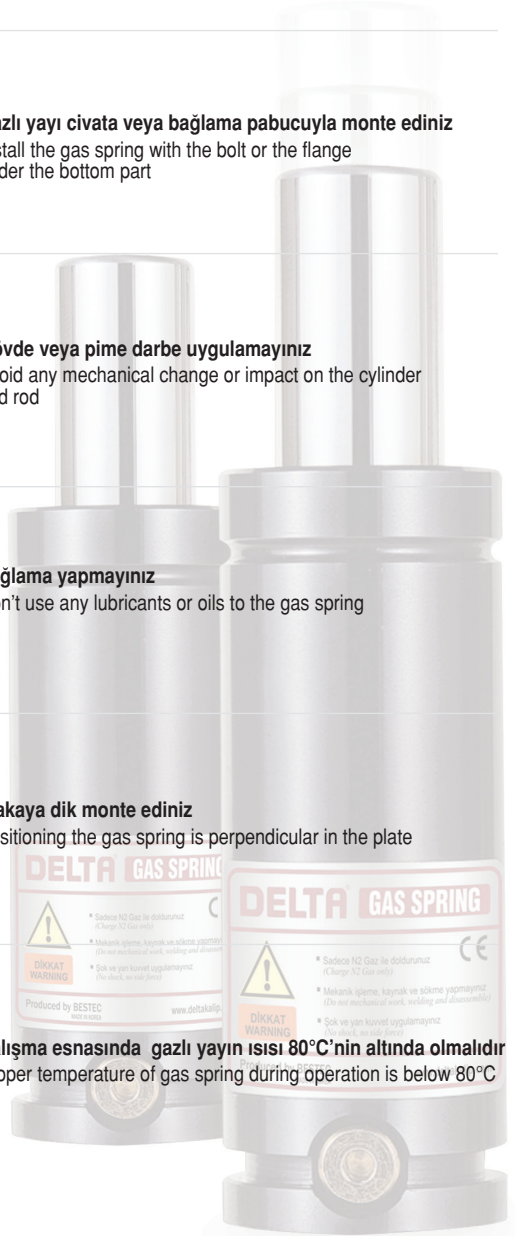

D100.01_00250

Gazlı Yay
Gas Springs
ISO 11901 / CNOMO E.24.54.815.N / ~ VDI 3003



| Sipariş Kodu | PSA Mabec Code | Strok Maks. Stroke Max. | l min | l |
|-------------------|----------------|-------------------------|-------|-------|
| D100.01_00250.010 | X346590038 | 10 | 60 | 70 |
| 013 | | 12,7 | 62,7 | 75,4 |
| 016 | X346590039 | 16 | 66 | 82 |
| 019 | | 19 | 69 | 88 |
| 025 | X346590037 | 25 | 75 | 100 |
| 038 | | 38,1 | 88,1 | 126,2 |
| 050 | X346590036 | 50 | 100 | 150 |
| 063 | Z000382437 | 63,5 | 113,5 | 177 |
| 080 | X346590261 | 80 | 130 | 210 |
| 100 | | 100 | 150 | 250 |

Kullanılan Gaz / Pressure Medium : Nitrojen N₂ / Nitrogen N₂
Maks. Dolum Basıncı / Max. Filling Pressure : 150 Bar
Min. Dolum Basıncı / Min. Filling Pressure : 50 Bar
Çalışma Sıcaklığı / Working Temperature : 0°C / +80°C
Sıcaklığa Bağlı Kuvvet Artışı / Temperature Related Force Increase : ±0.3%/°C
Önerilen Strok/dk. / Recommended Extensions Per minute : 80 - 100 (20°C)
Maks. Piston Hızı / Max. Piston Speed : 1.6 m/s

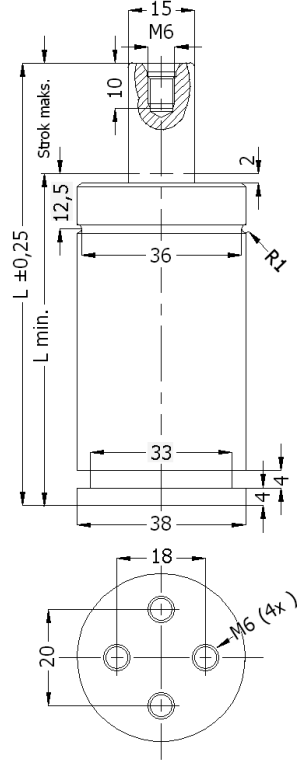

Yay Kuvveti Strok Tablosu

Spring Force - Stroke Diagram

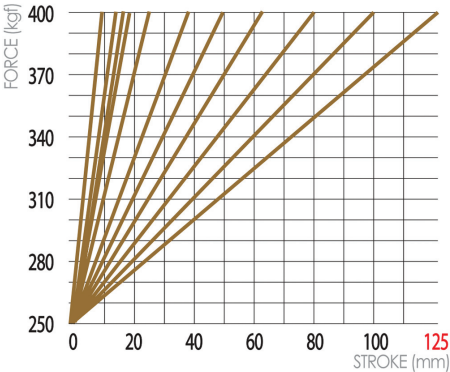

D100.50.01_00250

Gazlı Yay Bağlama Pabucu
Gas Springs Mounting Clamp

Malzeme - Material : Çelik (Steel)

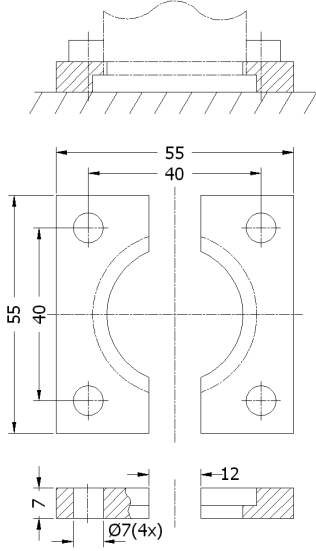

| Sipariş Kodu | PSA Mabec Code |
|------------------|----------------|
| D100.50.01_00250 | Z000304144 |

D100.50.02_00250

Gazlı Yay Bağlama Pabucu
Gas Springs Mounting Clamp

Malzeme - Material : Çelik (Steel)

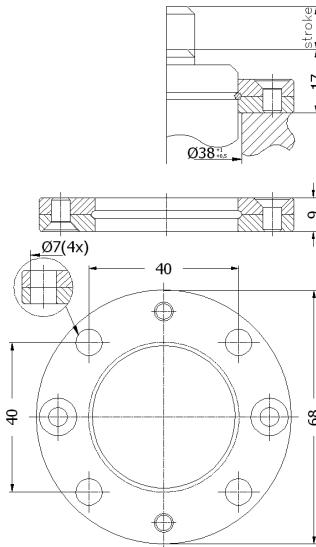

| Sipariş Kodu | PSA Mabec Code |
|------------------|----------------|
| D100.50.02_00250 | X346591660 |

D100.01_00500

Gazlı Yay
Gas Springs
ISO 11901 / CNOMO E.24.54.815.N / VDI 3003



| Sipariş Kodu | PSA Mabec Code | Strok Maks. Stroke Max. | l min | l |
|-------------------|----------------|-------------------------|-------|-------|
| D100.01_00500.010 | | 10 | 95 | 105 |
| 013 | | 12,7 | 97,7 | 110,4 |
| 016 | | 16 | 101 | 117 |
| 019 | | 19 | 104 | 123 |
| 025 | X346590337 | 25 | 110 | 135 |
| 038 | | 38,1 | 123,1 | 161,2 |
| 050 | X346590336 | 50 | 135 | 185 |
| 063 | Z000234960 | 63,5 | 148,5 | 212 |
| 080 | X346590335 | 80 | 165 | 245 |
| 100 | | 100 | 185 | 285 |
| 125 | | 125 | 210 | 335 |

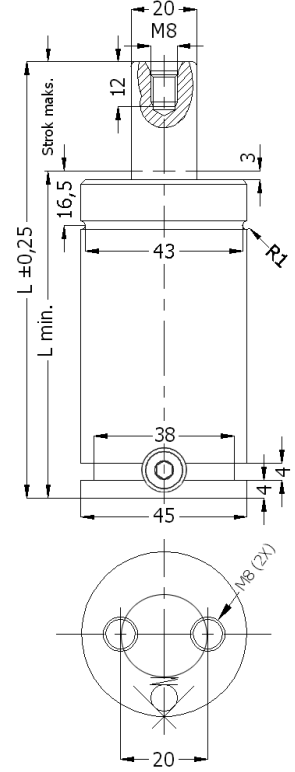

Kullanılan Gaz / Pressure Medium : Nitrojen N₂ / Nitrogen N₂
Maks. Dolu Basıncı / Max. Filling Pressure : 150 Bar
Min. Dolu Basıncı / Min. Filling Pressure : 25 Bar
Çalışma Sıcaklığı / Working Temperature : 0°C / +80°C
Sıcaklığa Bağlı Kuvvet Artışı / Temperature Related Force Increase : ±0.3%/°C
Önerilen Strok/dk. / Recommended Extensions Per minute : 40 - 80 (20°C)
Maks. Piston Hızı / Max. Piston Speed : 1.6 m/s

Yay Kuvveti Strok Tablosu
Spring Force - Stroke Diagram

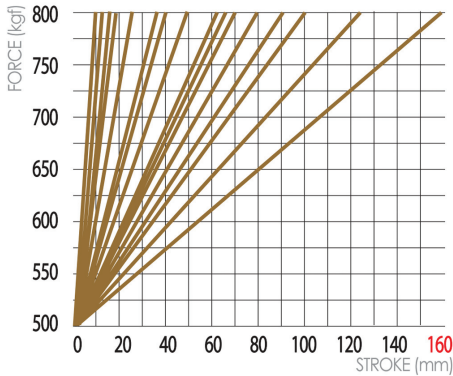

D100.50.01_00500

Gazlı Yay Bağlama Pabucu
Gas Springs Mounting Clamp

Malzeme - Material : Çelik (Steel)

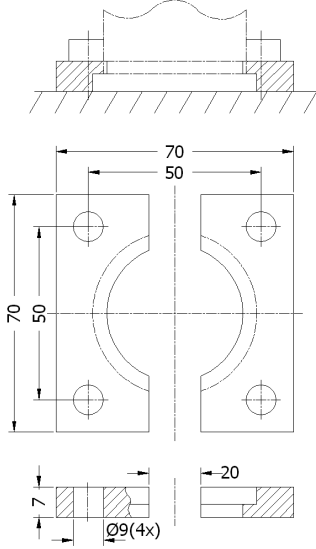

| Sipariş Kodu | PSA Mabec Code |
|------------------|-------------------|
| D100.50.01_00500 | Z000243509 |

D100.50.02_00500

Gazlı Yay Bağlama Pabucu
Gas Springs Mounting Clamp

Malzeme - Material : Çelik (Steel)

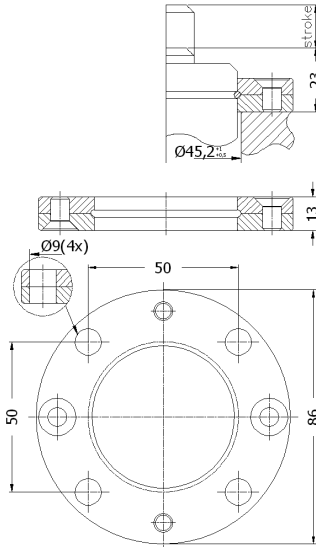

| Sipariş Kodu | PSA Mabec Code |
|------------------|-------------------|
| D100.50.02_00500 | Z000461359 |

D100.01_00750

Gazlı Yay
Gas Springs
ISO 11901 / CNOMO E.24.54.815.N / VDI 3003 / EM 2454 700 / D



| Sipariş Kodu | PSA Mabec Code | Strok Maks. Stroke Max. | l min | l |
|-------------------|----------------|-------------------------|-------|-------|
| D100.01_00750.013 | | 12,7 | 107,7 | 120,4 |
| 025 | X346590035 | 25 | 120 | 145 |
| 038 | | 38,1 | 133,1 | 171,2 |
| 050 | X346590034 | 50 | 145 | 195 |
| 063 | Z000304414 | 63,5 | 158,5 | 222 |
| 080 | X346590033 | 80 | 175 | 255 |
| 100 | X346590032 | 100 | 195 | 295 |
| 125 | X346590260 | 125 | 220 | 345 |
| 160 | X346590253 | 160 | 255 | 415 |

Kullanılan Gaz / Pressure Medium : Nitrojen N₂ / Nitrogen N₂
 Maks. Dolum Basıncı / Max. Filling Pressure : 150 Bar
 Min. Dolum Basıncı / Min. Filling Pressure : 25 Bar
 Çalışma Sıcaklığı / Working Temperature : 0°C / +80°C
 Sıcaklığa Bağlı Kuvvet Artışı / Temperature Related Force Increase : ±0.3%/°C
 Önerilen Strok/dk. / Recommended Extensions Per minute : 15 - 40 (20°C)
 Maks. Piston Hızı / Max. Piston Speed : 1.6 m/s

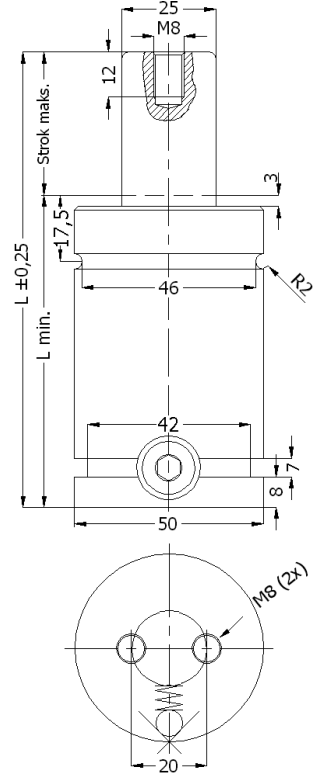

Yay Kuvveti Strok Tablosu
Spring Force - Stroke Diagram

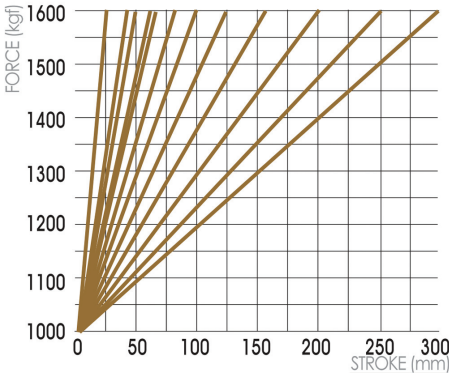

D100.50.01_00750

Gazlı Yay Bağlama Pabucu
Gas Springs Mounting Clamp

Malzeme - Material : Çelik (Steel)

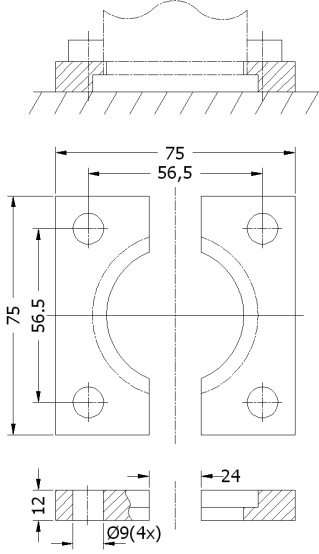

| Sipariş Kodu | PSA Mabec Code |
|------------------|-------------------|
| D100.50.01_00750 | X346591692 |

D100.50.02_00750

Gazlı Yay Bağlama Pabucu
Gas Springs Mounting Clamp

Malzeme - Material : Çelik (Steel)

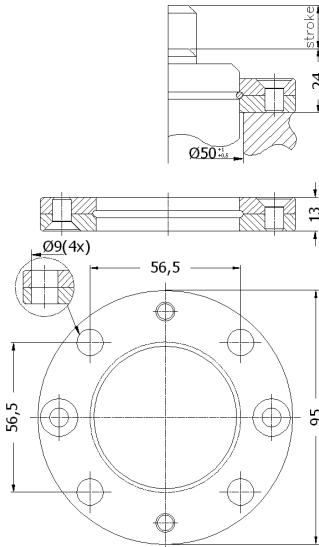

| Sipariş Kodu | PSA Mabec Code |
|------------------|-------------------|
| D100.50.02_00750 | X346591659 |

D100.01_01500

Gazlı Yay
Gas Springs
ISO 11901 / CNOMO E.24.54.815.N / VDI 3003 / EM 2454 700 / D



| Sipariş Kodu | PSA Mabec Code | Strok Maks. Stroke Max. | l min | l |
|-------------------|----------------|-------------------------|-------|-------|
| D100.01_01500.025 | X346590295 | 25 | 135 | 160 |
| 038 | | 38,1 | 148,1 | 186,2 |
| 050 | X346590041 | 50 | 160 | 210 |
| 063 | Z000296562 | 63,5 | 173,5 | 237 |
| 080 | X346590042 | 80 | 190 | 270 |
| 100 | X346590031 | 100 | 210 | 310 |
| 125 | X346590030 | 125 | 235 | 360 |
| 160 | X346590029 | 160 | 270 | 430 |

Kullanılan Gaz / Pressure Medium : Nitrojen N₂ / Nitrogen N₂
Maks. Dolum Basıncı / Max. Filling Pressure : 150 Bar
Min. Dolum Basıncı / Min. Filling Pressure : 25 Bar
Çalışma Sıcaklığı / Working Temperature : 0°C / +80°C
Sıcaklığa Bağlı Kuvvet Artışı / Temperature Related Force Increase : ±0.3%/°C
Önerilen Strok/dk. / Recommended Extensions Per minute : 15 - 40 (20°C)
Maks. Piston Hızı / Max. Piston Speed : 1.6 m/s

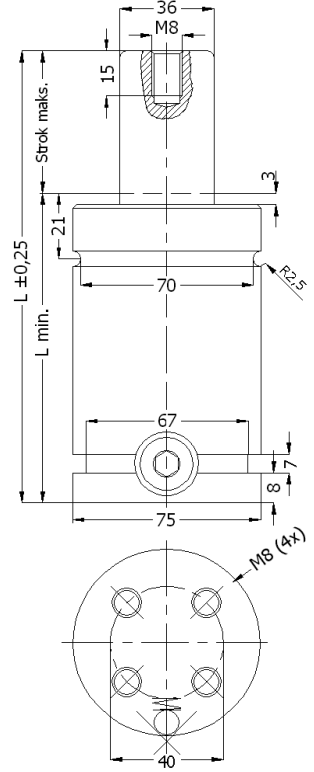

Yay Kuvveti Strok Tablosu
Spring Force - Stroke Diagram

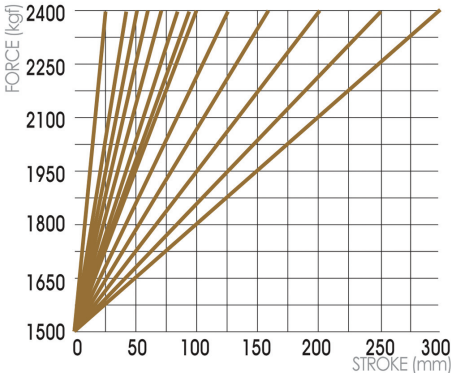

D100.50.01_01500

Gazlı Yay Bağlama Pabucu
Gas Springs Mounting Clamp

Malzeme - Material : Çelik (Steel)

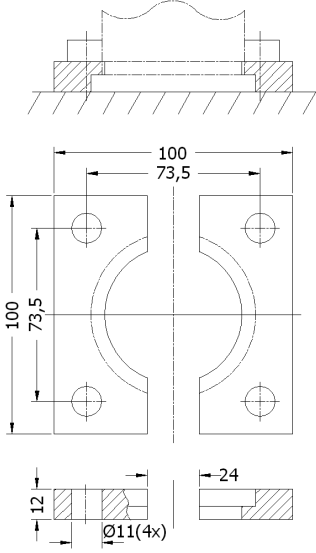

| Sipariş Kodu | PSA Mabec Code |
|------------------|-------------------|
| D100.50.01_01500 | X346591670 |

D100.50.02_01500

Gazlı Yay Bağlama Pabucu
Gas Springs Mounting Clamp

Malzeme - Material : Çelik (Steel)

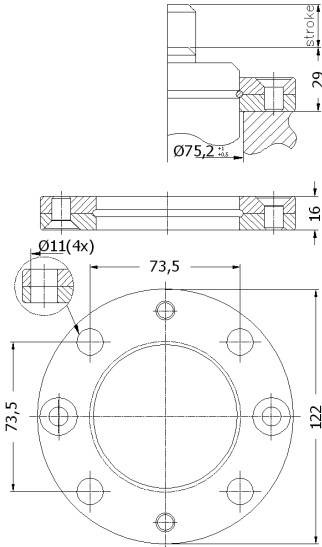

| Sipariş Kodu | PSA Mabec Code |
|------------------|-------------------|
| D100.50.02_01500 | X346591658 |

D100.01_03000

Gazlı Yay
Gas Springs
ISO 11901 / CNOMO E.24.54.815.N / VDI 3003



| Sipariş Kodu | PSA Mabec Code | Strok Maks. Stroke Max. | l min | l |
|-------------------|----------------|-------------------------|-------|-------|
| D100.01_03000.025 | X346590026 | 25 | 145 | 170 |
| 038 | | 38,1 | 158,1 | 196,2 |
| 050 | X346590294 | 50 | 170 | 220 |
| 063 | Z000459069 | 63,5 | 183,5 | 247 |
| 080 | X346590293 | 80 | 200 | 280 |
| 100 | X346590028 | 100 | 220 | 320 |
| 125 | X346590339 | 125 | 245 | 370 |
| 160 | X346590252 | 160 | 280 | 440 |

Kullanılan Gaz / Pressure Medium : Nitrojen N₂ / Nitrogen N₂
Maks. Dolum Basıncı / Max. Filling Pressure : 150 Bar
Min. Dolum Basıncı / Min. Filling Pressure : 25 Bar
Çalışma Sıcaklığı / Working Temperature : 0°C / +80°C
Sıcaklığa Bağlı Kuvvet Artışı / Temperature Related Force Increase : ±0.3%/°C
Önerilen Strok/dk. / Recommended Extensions Per minute : 15 - 40 (20°C)
Maks. Piston Hızı / Max. Piston Speed : 1.6 m/s

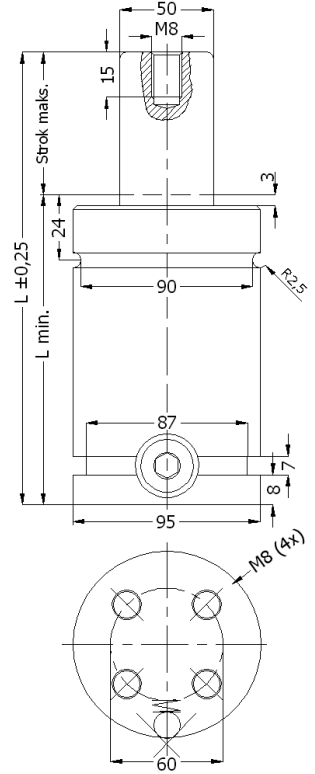

Yay Kuvveti Strok Tablosu
Spring Force - Stroke Diagram

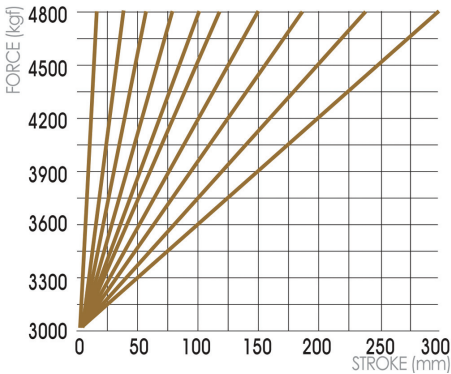

D100.50.01_03000

Gazlı Yay Bağlama Pabucu
Gas Springs Mounting Clamp

Malzeme - Material : Çelik (Steel)

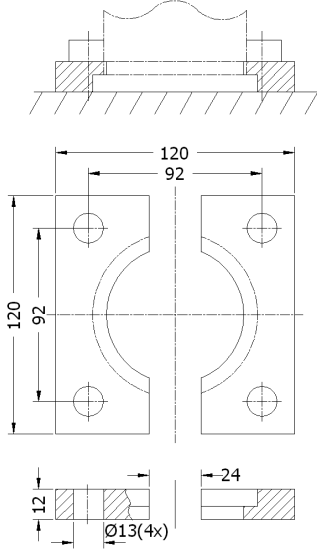

| Sipariş Kodu | PSA Mabec Code |
|------------------|-------------------|
| D100.50.01_03000 | X346591686 |

D100.50.02_03000

Gazlı Yay Bağlama Pabucu
Gas Springs Mounting Clamp

Malzeme - Material : Çelik (Steel)

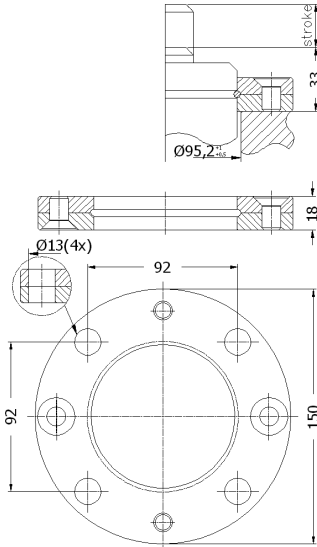

| Sipariş Kodu | PSA Mabec Code |
|------------------|-------------------|
| D100.50.02_03000 | X346591657 |

D100.01_05000

Gazlı Yay
Gas Springs
ISO 11901 / CNOMO E.24.54.815.N / VDI 3003



| Sipariş Kodu | PSA Mabec Code | Strok Maks. Stroke Max. | l min | l |
|-------------------|----------------|-------------------------|-------|-------|
| D100.01_05000.025 | Z000410553 | 25 | 165 | 190 |
| 038 | | 38,1 | 178,1 | 216,2 |
| 050 | X346590027 | 50 | 190 | 240 |
| 063 | | 63,5 | 203,5 | 267 |
| 080 | Z000492151 | 80 | 220 | 300 |
| 100 | Z000301877 | 100 | 240 | 340 |
| 125 | Z000239128 | 125 | 265 | 390 |
| 160 | | 160 | 300 | 460 |

Kullanılan Gaz / Pressure Medium : Nitrojen N₂ / Nitrogen N₂
 Maks. Dolum Basıncı / Max. Filling Pressure : 150 Bar
 Min. Dolum Basıncı / Min. Filling Pressure : 25 Bar
 Çalışma Sıcaklığı / Working Temperature : 0°C / +80°C
 Sıcaklığa Bağlı Kuvvet Artışı / Temperature Related Force Increase : ±0.3%/°C
 Önerilen Strok/dk. / Recommended Extensions Per minute : 15 - 40 (20°C)
 Maks. Piston Hızı / Max. Piston Speed : 1.6 m/s

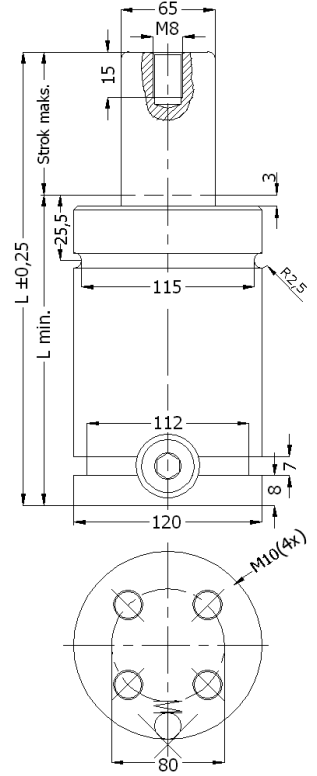

Yay Kuvveti Strok Tablosu
Spring Force - Stroke Diagram

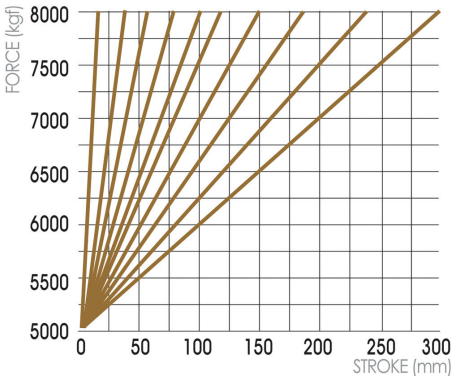

D100.50.01_05000

Gazlı Yay Bağlama Pabucu
Gas Springs Mounting Clamp

Malzeme - Material : Çelik (Steel)

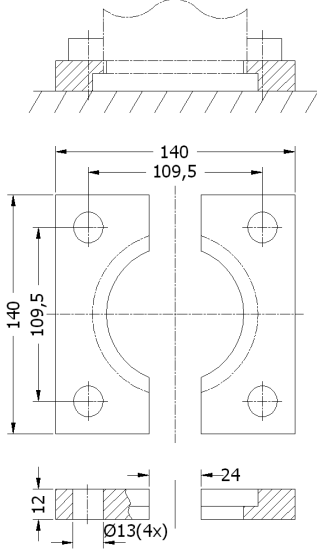

| Sipariş Kodu | PSA Mabec Code |
|------------------|-------------------|
| D100.50.01_05000 | X346591688 |

D100.50.02_05000

Gazlı Yay Bağlama Pabucu
Gas Springs Mounting Clamp

Malzeme - Material : Çelik (Steel)

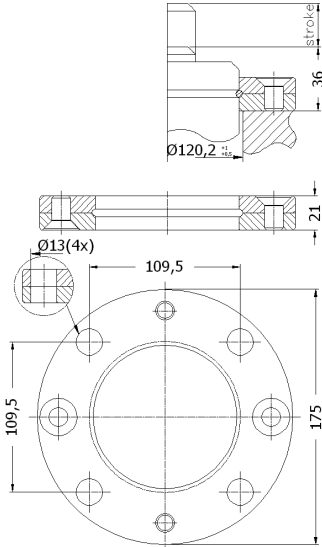

| Sipariş Kodu | PSA Mabec Code |
|------------------|-------------------|
| D100.50.02_05000 | X346591656 |

D100.02_00320

Gazlı Yay
Gas Springs



| Sipariş Kodu | Strok Maks. Stroke Max. | l min | l |
|-------------------|----------------------------|-------|-----|
| D100.02_00320.007 | 7 | 37 | 44 |
| 010 | 10 | 40 | 50 |
| 015 | 15 | 45 | 60 |
| 019 | 19 | 49 | 68 |
| 025 | 25 | 55 | 80 |
| 038 | 38 | 68 | 106 |
| 050 | 50 | 80 | 130 |
| 063 | 63 | 93 | 156 |
| 075 | 75 | 110 | 185 |
| 080 | 80 | 115 | 195 |
| 100 | 100 | 135 | 235 |
| 125 | 125 | 160 | 285 |

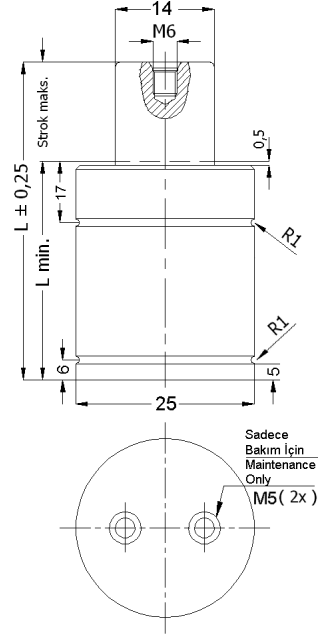

Kullanılan Gaz / Pressure Medium : Nitrojen N₂ / Nitrogen N₂
Maks. Dolum Basıncı / Max. Filling Pressure : 180 Bar
Min. Dolum Basıncı / Min. Filling Pressure : 25 Bar
Çalışma Sıcaklığı / Working Temperature : 0°C / +80°C
Sıcaklığa Bağlı Kuvvet Artışı / Temperature Related Force Increase : ±0.3%/°C
Önerilen Strok/dk. / Recommended Extensions Per minute : 40 - 100 (20°C)
Maks. Piston Hızı / Max. Piston Speed : 1.6 m/s

Yay Kuvveti Strok Tablosu
Spring Force - Stroke Diagram

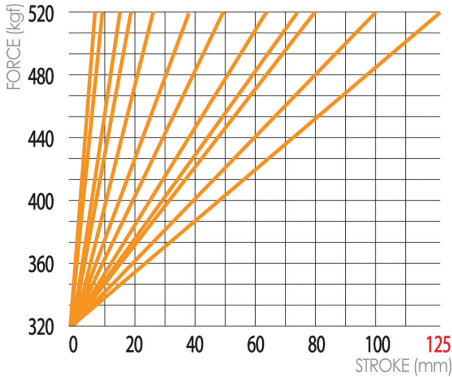

D100.02_00350

Gazlı Yay
Gas Springs
VDI 3003



| Sipariş Kodu | Strok Maks. Stroke Max. | l min | l |
|-------------------|----------------------------|-------|-----|
| D100.02_00350.010 | 10 | 40 | 50 |
| 013 | 13 | 43 | 56 |
| 016 | 16 | 46 | 62 |
| 019 | 19 | 49 | 68 |
| 025 | 25 | 55 | 80 |
| 032 | 32 | 62 | 94 |
| 038 | 38 | 68 | 106 |
| 050 | 50 | 80 | 130 |
| 063 | 63 | 93 | 156 |
| 075 | 75 | 105 | 180 |
| 080 | 80 | 110 | 190 |
| 100 | 100 | 130 | 230 |
| 125 | 125 | 155 | 280 |

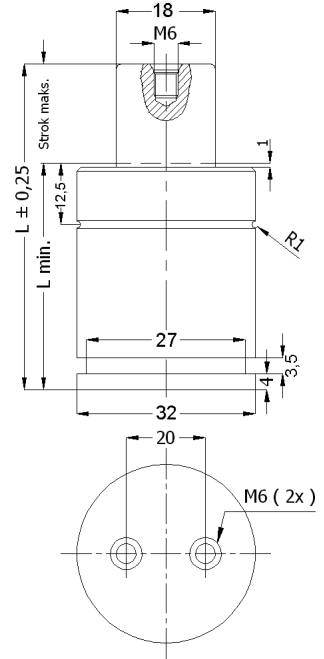

Kullanılan Gaz / Pressure Medium : Nitrojen N₂ / Nitrogen N₂
Maks. Dolun Basıncı / Max. Filling Pressure : 180 Bar
Min. Dolun Basıncı / Min. Filling Pressure : 25 Bar
Çalışma Sıcaklığı / Working Temperature : 0°C / +80°C
Sıcaklığa Bağlı Kuvvet Artışı / Temperature Related Force Increase : ±0.3%/°C
Önerilen Strok/dk. / Recommended Extensions Per minute : 20 - 100 (20°C)
Maks. Piston Hızı / Max. Piston Speed : 1.6 m/s

Yay Kuvveti Strok Tablosu Spring Force - Stroke Diagram

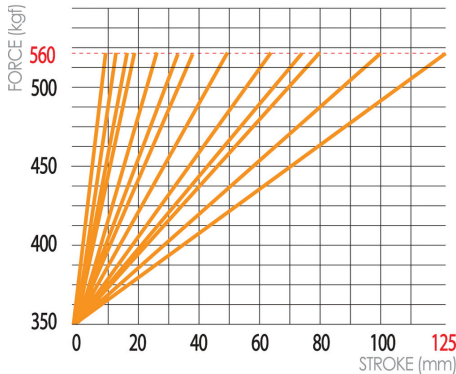

D100.02_00500

Gazlı Yay
Gas Springs
VDI 3003 / CNOMO



| Sipariş Kodu | PSA Mabec Code | Strok Maks. Stroke Max. | l min | l |
|-------------------|----------------|-------------------------|-------|-----|
| D100.02_00500.010 | Z000459071 | 10 | 40 | 50 |
| 013 | | 13 | 43 | 56 |
| 016 | Z000459074 | 16 | 46 | 62 |
| 019 | | 19 | 49 | 68 |
| 025 | Z000459075 | 25 | 55 | 80 |
| 032 | | 32 | 62 | 94 |
| 038 | | 38 | 68 | 106 |
| 050 | Z000504472 | 50 | 80 | 130 |
| 063 | | 63 | 93 | 156 |
| 075 | | 75 | 105 | 180 |
| 080 | Z000459076 | 80 | 110 | 190 |
| 100 | Z000459077 | 100 | 130 | 230 |
| 125 | Z000459078 | 125 | 155 | 280 |

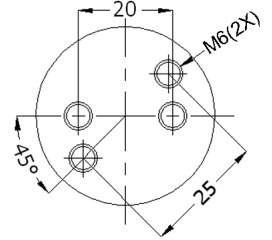
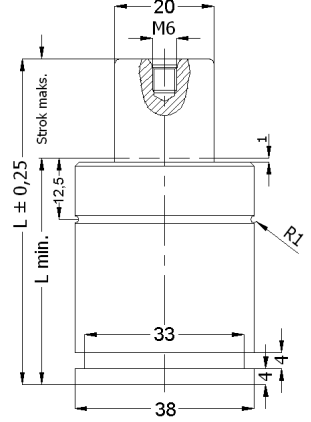

Kullanılan Gaz / Pressure Medium : Nitrojen N₂ / Nitrogen N₂
Maks. Dolum Basıncı / Max. Filling Pressure : 150 Bar
Min. Dolum Basıncı / Min. Filling Pressure : 25 Bar
Çalışma Sıcaklığı / Working Temperature : 0°C / +80°C
Sıcaklığa Bağlı Kuvvet Artışı / Temperature Related Force Increase : ±0.3%/°C
Önerilen Strok/dk. / Recommended Extensions Per minute : 20 - 100 (20°C)
Maks. Piston Hızı / Max. Piston Speed : 1.6 m/s

Yay Kuvveti Strok Tablosu
Spring Force - Stroke Diagram

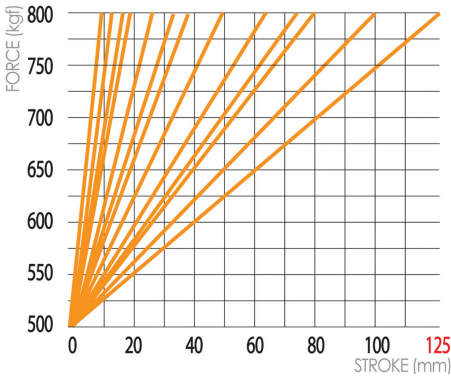

D100.02_00750

Gazlı Yay
Gas Springs
VDI 3003 / CNOMO



| Sipariş Kodu | PSA Mabec Code | Strok Maks. Stroke Max. | l min | l |
|-------------------|----------------|-------------------------|-------|-----|
| D100.02_00750.010 | Z000459079 | 10 | 42 | 52 |
| 013 | | 13 | 45 | 58 |
| 016 | Z000459080 | 16 | 48 | 64 |
| 019 | | 19 | 51 | 70 |
| 025 | Z000459087 | 25 | 57 | 82 |
| 032 | | 32 | 64 | 96 |
| 038 | | 38 | 70 | 108 |
| 050 | Z000459088 | 50 | 82 | 132 |
| 063 | Z000459089 | 63 | 95 | 158 |
| 075 | | 75 | 107 | 182 |
| 080 | Z000459090 | 80 | 112 | 192 |
| 100 | Z000459208 | 100 | 132 | 232 |
| 125 | Z000459165 | 125 | 157 | 282 |

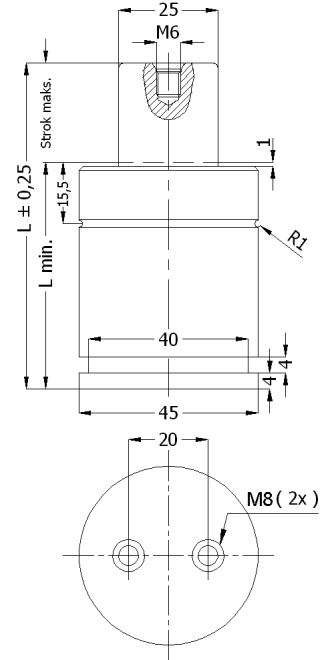

Kullanılan Gaz / Pressure Medium : Nitrojen N₂ / Nitrogen N₂
Maks. Dolum Basıncı / Max. Filling Pressure : 150 Bar
Min. Dolum Basıncı / Min. Filling Pressure : 25 Bar
Çalışma Sıcaklığı / Working Temperature : 0°C / +80°C
Sıcaklığa Bağlı Kuvvet Artışı / Temperature Related Force Increase : ±0.3%/°C
Önerilen Strok/dk. / Recommended Extensions Per minute : 20 - 100 (20°C)
Maks. Piston Hızı / Max. Piston Speed : 1.6 m/s

Yay Kuvveti Strok Tablosu
Spring Force - Stroke Diagram

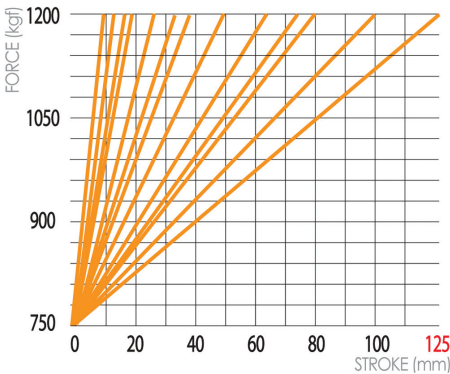

D100.50.01_00500

Gazlı Yay Bağlama Pabucu
Gas Springs Mounting Clamp

Malzeme - Material : Çelik (Steel)

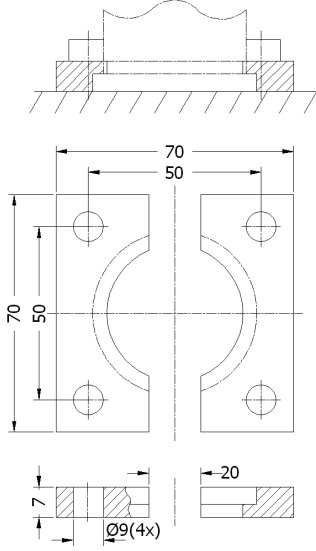

| Sipariş Kodu | PSA Mabec Code |
|------------------|-------------------|
| D100.50.01_00500 | Z000243509 |

D100.50.02_00500

Gazlı Yay Bağlama Pabucu
Gas Springs Mounting Clamp

Malzeme - Material : Çelik (Steel)

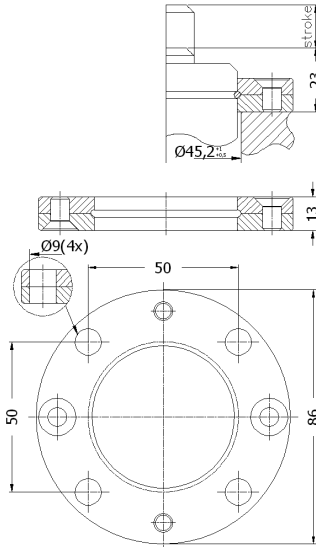

| Sipariş Kodu | PSA Mabec Code |
|------------------|-------------------|
| D100.50.02_00500 | Z000461359 |

D100.02_01000

Gazlı Yay
Gas Springs
VDI 3003 / CNOMO



| Sipariş Kodu | PSA Mabec Code | Strok Maks. Stroke Max. | l min | l |
|-------------------|----------------|-------------------------|-------|-----|
| D100.02_01000.013 | | 13 | 51 | 64 |
| 016 | Z000459167 | 16 | 54 | 70 |
| 019 | | 19 | 57 | 76 |
| 025 | Z000459168 | 25 | 63 | 88 |
| 032 | | 32 | 70 | 102 |
| 038 | | 38 | 76 | 114 |
| 050 | Z000376302 | 50 | 88 | 138 |
| 063 | Z000459169 | 63 | 101 | 164 |
| 075 | | 75 | 113 | 188 |
| 080 | Z000459170 | 80 | 118 | 198 |
| 100 | Z000459171 | 100 | 138 | 238 |
| 125 | Z000459173 | 125 | 163 | 288 |

Kullanılan Gaz / Pressure Medium : Nitrojen N₂ / Nitrogen N₂
Maks. Dolum Basıncı / Max. Filling Pressure : 150 Bar
Min. Dolum Basıncı / Min. Filling Pressure : 25 Bar
Çalışma Sıcaklığı / Working Temperature : 0°C / +80°C
Sıcaklığa Bağlı Kuvvet Artışı / Temperature Related Force Increase : ±0.3%/°C
Önerilen Strok/dk. / Recommended Extensions Per minute : 20 - 100 (20°C)
Maks. Piston Hızı / Max. Piston Speed : 1.6 m/s

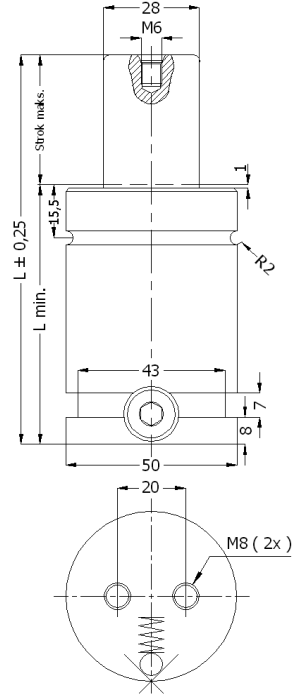

Yay Kuvveti Strok Tablosu
Spring Force - Stroke Diagram

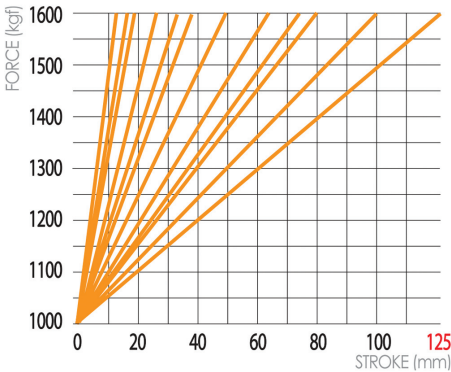

D100.50.01_00750

Gazlı Yay Bağlama Pabucu
Gas Springs Mounting Clamp

Malzeme - Material : Çelik (Steel)

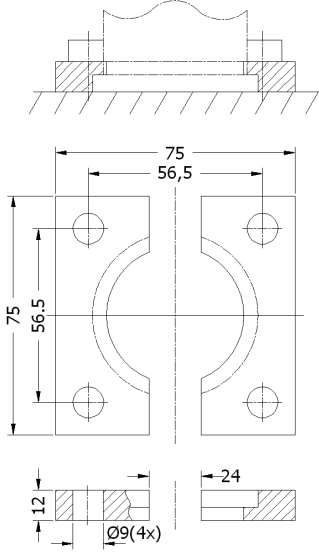

| Sipariş Kodu | PSA Mabec Code |
|------------------|-------------------|
| D100.50.01_00750 | X346591692 |

D100.50.02_00750

Gazlı Yay Bağlama Pabucu
Gas Springs Mounting Clamp

Malzeme - Material : Çelik (Steel)

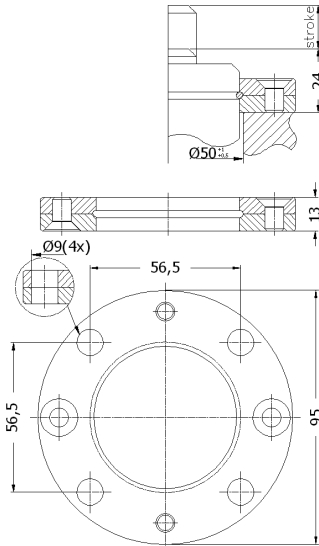

| Sipariş Kodu | PSA Mabec Code |
|------------------|-------------------|
| D100.50.02_00750 | X346591659 |

D100.02_01500

Gazlı Yay
Gas Springs
VDI 3003



| Sipariş Kodu | Strok Maks. Stroke Max. | l min | l |
|-------------------|----------------------------|-------|-----|
| D100.02_01500.013 | 13 | 57 | 70 |
| 016 | 16 | 60 | 76 |
| 019 | 19 | 63 | 82 |
| 025 | 25 | 69 | 94 |
| 032 | 32 | 76 | 108 |
| 038 | 38 | 82 | 120 |
| 050 | 50 | 94 | 144 |
| 063 | 63 | 107 | 170 |
| 075 | 75 | 119 | 194 |
| 080 | 80 | 124 | 204 |
| 100 | 100 | 144 | 244 |
| 125 | 125 | 169 | 294 |

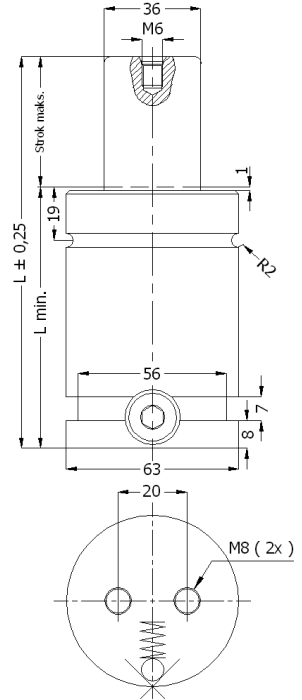

Kullanılan Gaz / Pressure Medium : Nitrojen N₂ / Nitrogen N₂
Maks. Dolum Basıncı / Max. Filling Pressure : 150 Bar
Min. Dolum Basıncı / Min. Filling Pressure : 25 Bar
Çalışma Sıcaklığı / Working Temperature : 0°C / +80°C
Sıcaklığa Bağlı Kuvvet Artışı / Temperature Related Force Increase : ±0.3%/°C
Önerilen Strok/dk. / Recommended Extensions Per minute : 50 - 100 (20°C)
Maks. Piston Hızı / Max. Piston Speed : 1.6 m/s

Yay Kuvveti Strok Tablosu
Spring Force - Stroke Diagram

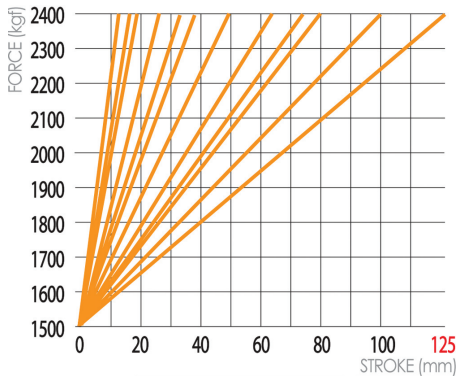

D100.50.01_01000

Gazlı Yay Bağlama Pabucu
Gas Springs Mounting Clamp

Malzeme - Material : Çelik (Steel)

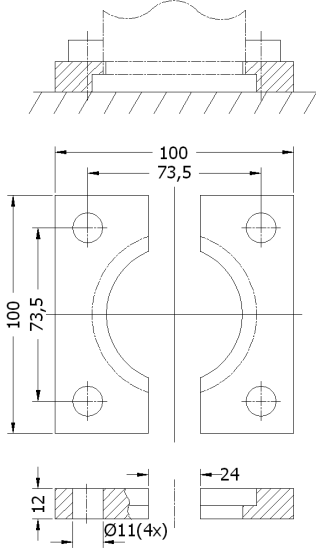

Sipariş Kodu

D100.50.01_01000

D100.02_02400

Gazlı Yay
Gas Springs
VDI 3003 / CNOMO



| Sipariş Kodu | PSA Mabec Code | Strok Maks. Stroke Max. | l min | l |
|-------------------|----------------|-------------------------|-------|-----|
| D100.02_02400.016 | Z000459174 | 16 | 61 | 77 |
| 019 | | 19 | 64 | 83 |
| 025 | Z000410552 | 25 | 70 | 95 |
| 032 | | 32 | 77 | 109 |
| 038 | | 38 | 83 | 121 |
| 050 | Z000459175 | 50 | 95 | 145 |
| 063 | Z000459177 | 63 | 108 | 171 |
| 075 | | 75 | 120 | 195 |
| 080 | Z000365402 | 80 | 125 | 205 |
| 100 | Z000459178 | 100 | 145 | 245 |
| 125 | Z000459179 | 125 | 170 | 295 |

Kullanılan Gaz / Pressure Medium : Nitrojen N₂ / Nitrogen N₂
Maks. Dolum Basıncı / Max. Filling Pressure : 150 Bar
Min. Dolum Basıncı / Min. Filling Pressure : 25 Bar
Çalışma Sıcaklığı / Working Temperature : 0°C / +80°C
Sıcaklığa Bağlı Kuvvet Artışı / Temperature Related Force Increase : ±0.3%/°C
Önerilen Strok/dk. / Recommended Extensions Per minute : 20 - 100 (20°C)
Maks. Piston Hızı / Max. Piston Speed : 1.6 m/s

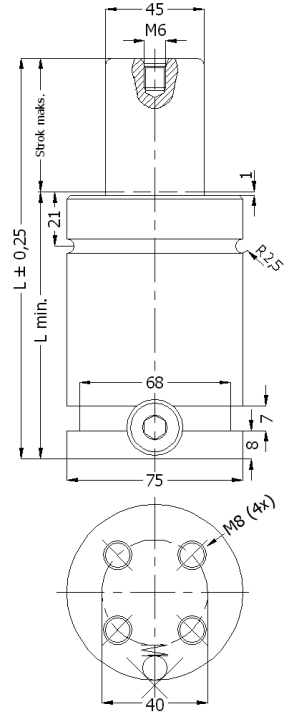

Yay Kuvveti Strok Tablosu
Spring Force - Stroke Diagram

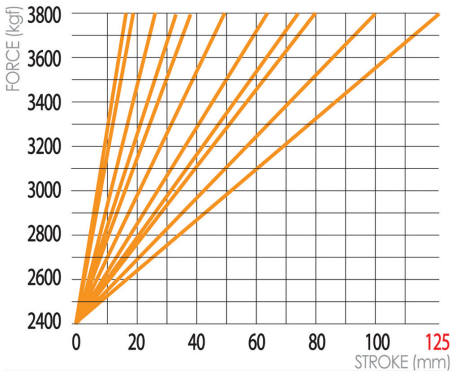

D100.50.01_01500

Gazlı Yay Bağlama Pabucu
Gas Springs Mounting Clamp

Malzeme - Material : Çelik (Steel)

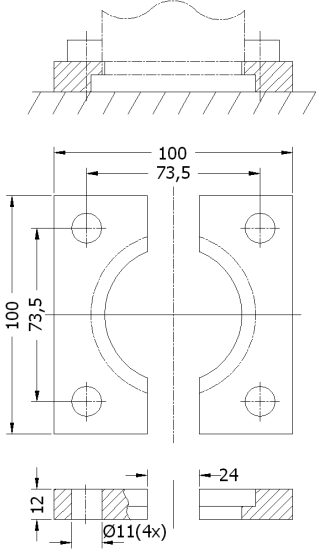

| Sipariş Kodu | PSA Mabec Code |
|------------------|-------------------|
| D100.50.01_01500 | X346591670 |

D100.50.02_01500

Gazlı Yay Bağlama Pabucu
Gas Springs Mounting Clamp

Malzeme - Material : Çelik (Steel)

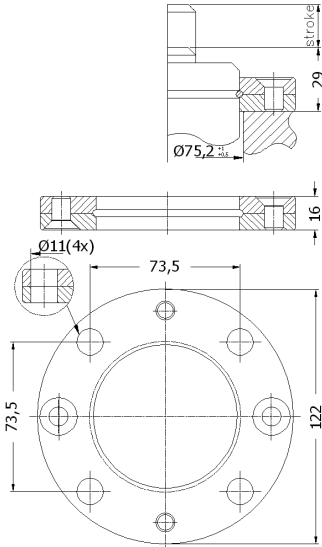

| Sipariş Kodu | PSA Mabec Code |
|------------------|-------------------|
| D100.50.02_01500 | X346591658 |

D100.02_04200

Gazlı Yay
Gas Springs
VDI 3003 / CNOMO



| Sipariş Kodu | PSA Mabec Code | Strok Maks. Stroke Max. | l min | l |
|-------------------|----------------|-------------------------|-------|-----|
| D100.02_04200.016 | Z000459180 | 16 | 74 | 90 |
| 019 | | 19 | 77 | 96 |
| 025 | Z000459181 | 25 | 83 | 108 |
| 032 | | 32 | 90 | 122 |
| 038 | | 38 | 96 | 134 |
| 050 | Z000414099 | 50 | 108 | 158 |
| 063 | | 63 | 121 | 184 |
| 075 | | 75 | 133 | 208 |
| 080 | Z000459182 | 80 | 138 | 218 |
| 100 | Z000459183 | 100 | 158 | 258 |
| 125 | Z000459184 | 125 | 183 | 308 |

Kullanılan Gaz / Pressure Medium : Nitrojen N₂ / Nitrogen N₂
Maks. Dolum Basıncı / Max. Filling Pressure : 150 Bar
Min. Dolum Basıncı / Min. Filling Pressure : 25 Bar
Çalışma Sıcaklığı / Working Temperature : 0°C / +80°C
Sıcaklığa Bağlı Kuvvet Artışı / Temperature Related Force Increase : ±0.3%/°C
Önerilen Strok/dk. / Recommended Extensions Per minute : 20 - 100 (20°C)
Maks. Piston Hızı / Max. Piston Speed : 1.6 m/s

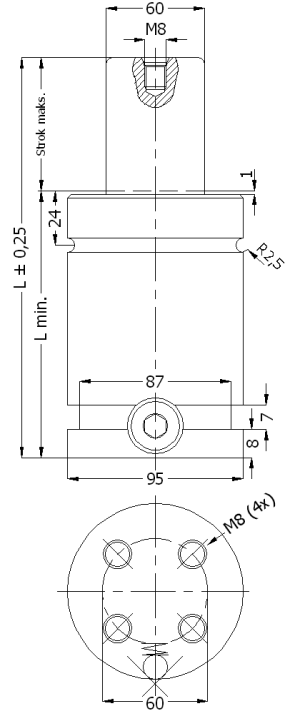

Yay Kuvveti Strok Tablosu
Spring Force - Stroke Diagram

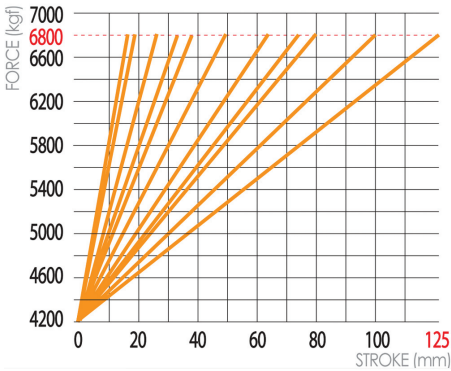

D100.50.01_03000

Gazlı Yay Bağlama Pabucu
Gas Springs Mounting Clamp

Malzeme - Material : Çelik (Steel)

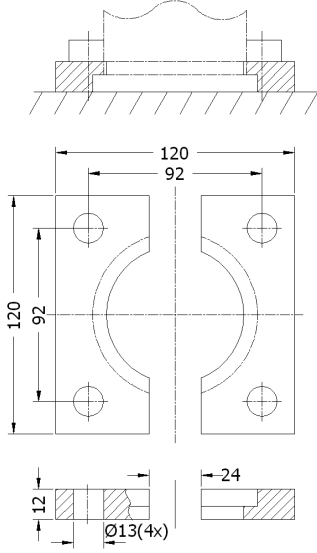

| Sipariş Kodu | PSA Mabec Code |
|------------------|-------------------|
| D100.50.01_03000 | X346591686 |

D100.50.02_03000

Gazlı Yay Bağlama Pabucu
Gas Springs Mounting Clamp

Malzeme - Material : Çelik (Steel)

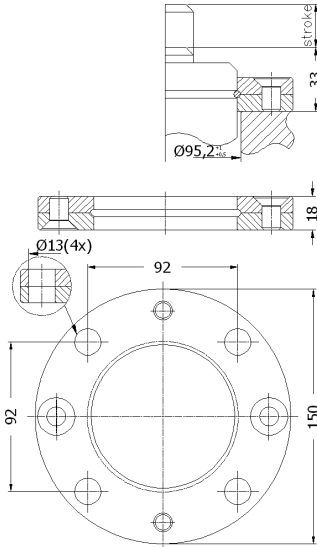

| Sipariş Kodu | PSA Mabec Code |
|------------------|-------------------|
| D100.50.02_03000 | X346591657 |

D100.02_06600

Gazlı Yay
Gas Springs
VDI 3003



| Sipariş Kodu | Strok Maks. Stroke Max. | l min | l |
|-------------------|----------------------------|-------|-----|
| D100.02_06600.016 | 16 | 84 | 100 |
| 019 | 19 | 87 | 106 |
| 025 | 25 | 93 | 118 |
| 032 | 32 | 100 | 132 |
| 038 | 38 | 106 | 144 |
| 050 | 50 | 118 | 168 |
| 063 | 63 | 131 | 194 |
| 075 | 75 | 143 | 218 |
| 080 | 80 | 148 | 228 |
| 100 | 100 | 168 | 268 |
| 125 | 125 | 193 | 318 |

Kullanılan Gaz / Pressure Medium : Nitrojen N₂ / Nitrogen N₂
Maks. Dolum Basıncı / Max. Filling Pressure : 150 Bar
Min. Dolum Basıncı / Min. Filling Pressure : 25 Bar
Çalışma Sıcaklığı / Working Temperature : 0°C / +80°C
Sıcaklığa Bağlı Kuvvet Artışı / Temperature Related Force Increase : ±0.3%/°C
Önerilen Strok/dk. / Recommended Extensions Per minute : 20 - 100 (20°C)
Maks. Piston Hızı / Max. Piston Speed : 1.6 m/s

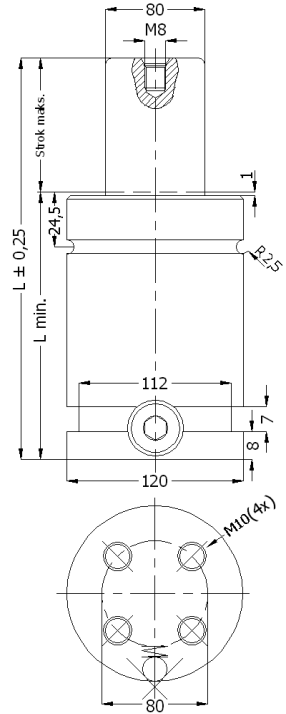

Yay Kuvveti Strok Tablosu
Spring Force - Stroke Diagram

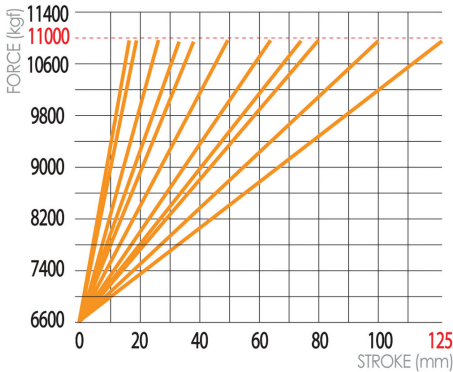

D100.50.01_05000

Gazlı Yay Bağlama Pabucu
Gas Springs Mounting Clamp

Malzeme - Material : Çelik (Steel)

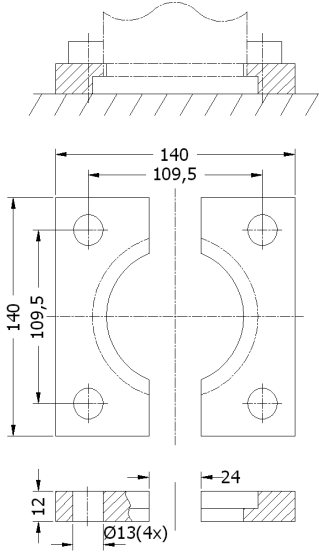

| Sipariş Kodu | PSA Mabec Code |
|------------------|-------------------|
| D100.50.01_05000 | X346591688 |

D100.50.02_05000

Gazlı Yay Bağlama Pabucu
Gas Springs Mounting Clamp

Malzeme - Material : Çelik (Steel)

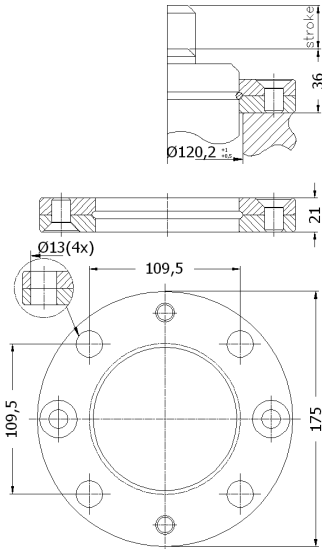

| Sipariş Kodu | PSA Mabec Code |
|------------------|-------------------|
| D100.50.02_05000 | X346591656 |

D70.01

Döküm Blok / Guide Bearing

Malzeme - Material: GG25



| | Ø | | | | | | | |
|--------------|----------|-----------|----------|-----------|----------|----------|-----------|-----------|
| Sipariş Kodu | d | d1 | h | h1 | a | b | e1 | e2 |
| D70.01_40 | 40 | 10 | 77 | 30 | 130 | 80 | 95 | 45 |
| 50 | 50 | 10 | 95 | 35 | 160 | 96 | 118 | 55 |
| 63 | 63 | 12 | 120 | 35 | 180 | 110 | 132 | 62 |
| 80 | 80 | 14 | 120 | 40 | 215 | 130 | 160 | 75 |

| Ød | M |
|----|----|
| 40 | 12 |
| 50 | 14 |
| 63 | 16 |
| 80 | 20 |

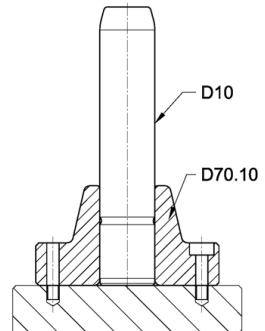
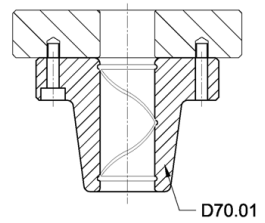
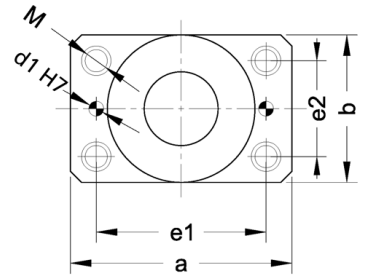
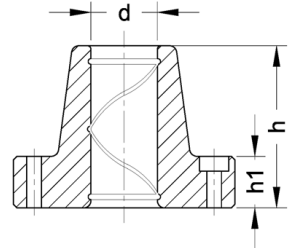

D70.02

Bronzlu Döküm Blok / Guide Bearing with Bronze

Malzeme - Material: GG25 / Bronze



| | Ø | | | | | | | |
|--------------|----|----|-----|----|-----|-----|-----|----|
| Sipariş Kodu | d | d1 | h | h1 | a | b | e1 | e2 |
| D70.02_40 | 40 | 10 | 77 | 30 | 130 | 80 | 95 | 45 |
| 50 | 50 | 10 | 95 | 35 | 160 | 96 | 118 | 55 |
| 63 | 63 | 12 | 120 | 35 | 180 | 110 | 132 | 62 |
| 80 | 80 | 14 | 120 | 40 | 215 | 130 | 160 | 75 |

| Ød | M |
|----|----|
| 40 | 12 |
| 50 | 14 |
| 63 | 16 |
| 80 | 20 |

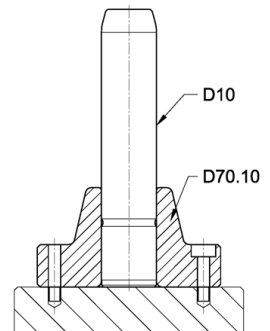
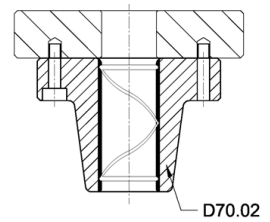
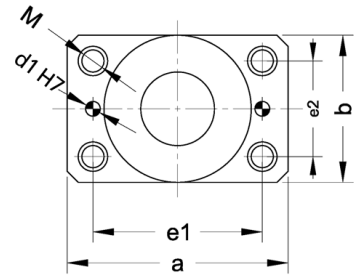
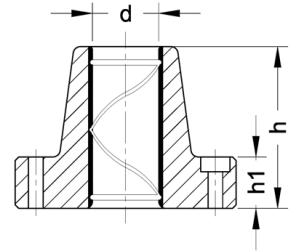

D70.03

Çelik Kaymalı Döküm Blok / Guide Bearing with Steel

Malzeme - Material : GG25 / Asil Çelik 1.7131 (16MnCr5)
 Sertlik - Hardness : 62± 2 HRC
 Isil İşlem - Heat Treatment : Sementasyon (Case Hardened)



| Sipariş Kodu | Ø d | d1 | h | h1 | a | b | e1 | e2 |
|--------------|-----|----|-----|----|-----|-----|-----|----|
| D70.03_40 | 40 | 10 | 77 | 30 | 130 | 80 | 95 | 45 |
| 50 | 50 | 10 | 95 | 35 | 160 | 96 | 118 | 55 |
| 63 | 63 | 12 | 120 | 35 | 180 | 110 | 132 | 62 |
| 80 | 80 | 14 | 120 | 40 | 215 | 130 | 160 | 75 |

| Ød | M |
|----|----|
| 40 | 12 |
| 50 | 14 |
| 63 | 16 |
| 80 | 20 |

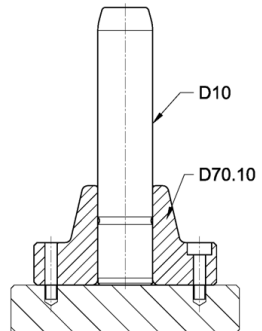
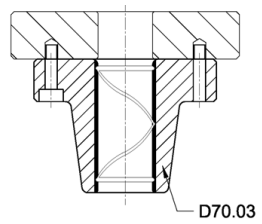
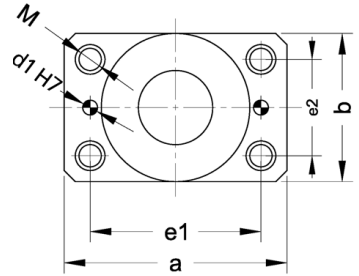
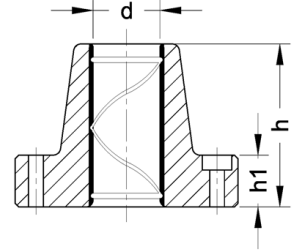

D70.04

Bilyalı Döküm Blok / Guide Bearing with Ball Cage

Malzeme - Material : GG25 /Asil Çelik 1.3505 (100Cr6)
 Sertlik - Hardness : 62± 2 HRC
 Isil İşlem - Heat Treatment : Sementasyon (Case Hardened)



| | Ø | | | | | | | |
|--------------|----|----|-----|----|-----|-----|-----|----|
| Sipariş Kodu | d | d1 | h | h1 | a | b | e1 | e2 |
| D70.04_40 | 40 | 10 | 77 | 30 | 130 | 80 | 95 | 45 |
| 50 | 50 | 10 | 95 | 35 | 160 | 96 | 118 | 55 |
| 63 | 63 | 12 | 120 | 35 | 180 | 110 | 132 | 62 |
| 80 | 80 | 14 | 120 | 40 | 215 | 130 | 160 | 75 |

| Ød | M |
|----|----|
| 40 | 12 |
| 50 | 14 |
| 63 | 16 |
| 80 | 20 |

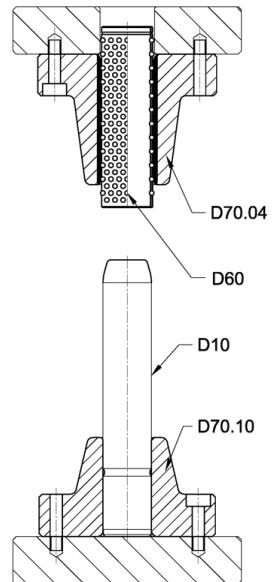
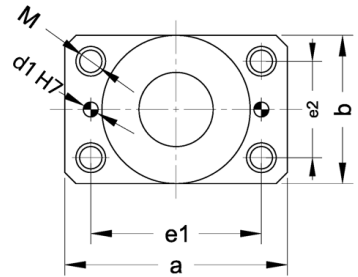
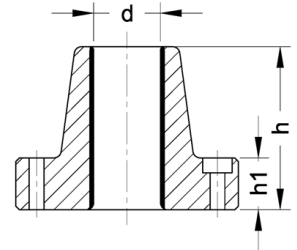

D70.05

Grafitli Döküm Blok / Guide Bearing Non-Lubricant

Malzeme - Material: GG25 / SAE 430B

Sertlik - Hardness : HB≥180



| Sipariş Kodu | Ød | d1 | h | h1 | a | b | e1 | e2 |
|--------------|----|----|-----|----|-----|-----|-----|----|
| D70.05_40 | 40 | 10 | 77 | 30 | 130 | 80 | 95 | 45 |
| 50 | 50 | 10 | 95 | 35 | 160 | 96 | 118 | 55 |
| 63 | 63 | 12 | 120 | 35 | 180 | 110 | 132 | 62 |
| 80 | 80 | 14 | 120 | 40 | 215 | 130 | 160 | 75 |

| Ød | M |
|----|----|
| 40 | 12 |
| 50 | 14 |
| 63 | 16 |
| 80 | 20 |

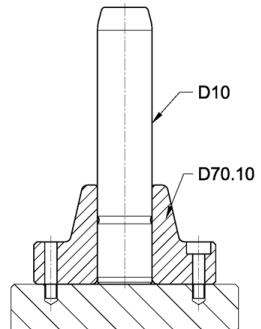
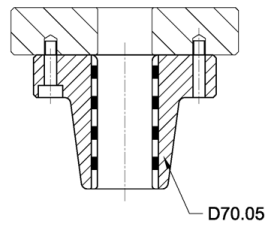
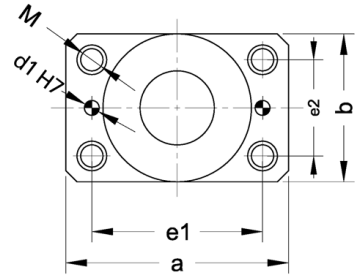
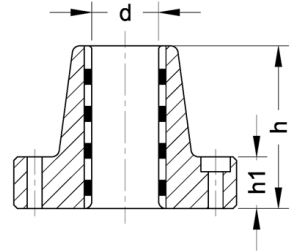

D70.10

Kolon Sabitleme Bloğu / Pillar Bearing

Malzeme - Material: GG25



| Sipariş Kodu | Ø | | | | | | | |
|--------------|----|----|-----|----|-----|-----|-----|----|
| | d | d1 | h | h1 | a | b | e1 | e2 |
| D70.10_40 | 40 | 10 | 77 | 30 | 130 | 80 | 95 | 45 |
| 50 | 50 | 10 | 95 | 35 | 160 | 96 | 118 | 55 |
| 63 | 63 | 12 | 120 | 35 | 180 | 110 | 132 | 62 |
| 80 | 80 | 14 | 120 | 40 | 215 | 130 | 160 | 75 |

| Ød | M |
|----|----|
| 40 | 12 |
| 50 | 14 |
| 63 | 16 |
| 80 | 20 |

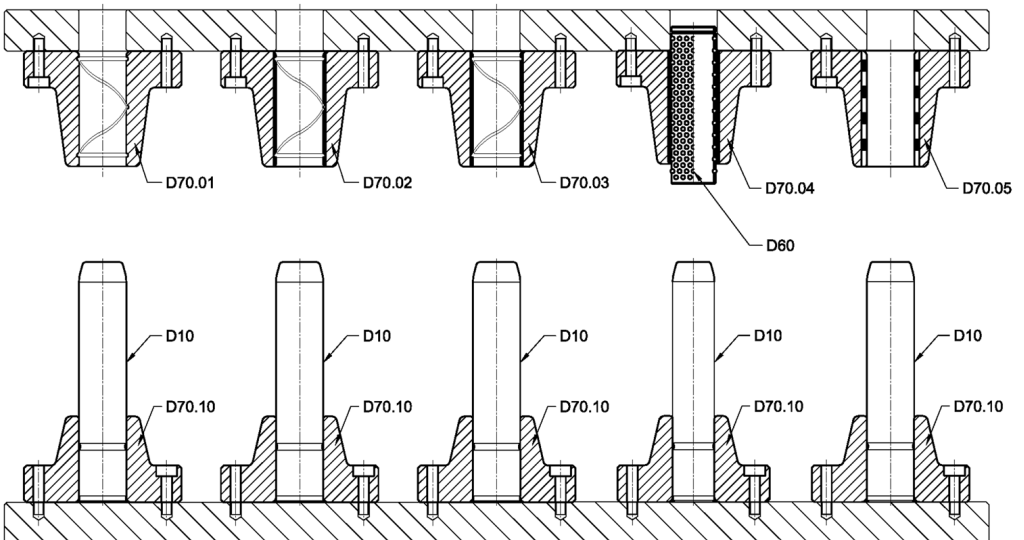
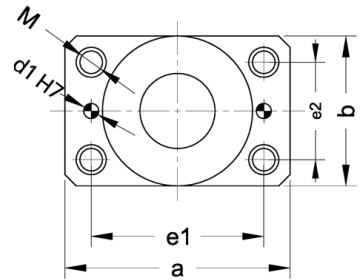
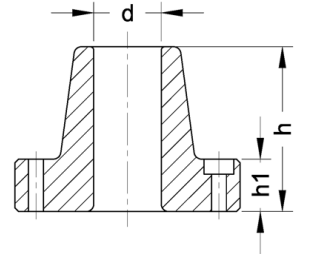

D70.011

Döküm Set / Guide Bearing Set

Malzeme - Material : GG25 / Asil Çelik 1.1213 (Cf 53)
 Sertlik - Hardness : 62± 2 HRC
 Isıl İşlem - Heat Treatment: İndüksiyon (Induction)



| Sipariş Kodu | Ø d | L | d1 | h | h1 | a | b | e1 | e2 |
|---------------|-----|-----|----|-----|----|-----|-----|-----|----|
| D70.011_40180 | 40 | 180 | 10 | 77 | 30 | 130 | 80 | 95 | 45 |
| 220 | | 220 | | | | | | | |
| 260 | | 260 | | | | | | | |
| 300 | | 300 | | | | | | | |
| 355 | | 355 | | | | | | | |
| 400 | | 400 | | | | | | | |
| D70.011_50200 | 50 | 200 | 10 | 95 | 35 | 160 | 96 | 118 | 55 |
| 240 | | 240 | | | | | | | |
| 280 | | 280 | | | | | | | |
| 315 | | 315 | | | | | | | |
| 355 | | 355 | | | | | | | |
| 400 | | 400 | | | | | | | |
| 450 | | 450 | | | | | | | |
| D70.011_63240 | 63 | 240 | 12 | 120 | 35 | 180 | 110 | 132 | 62 |
| 280 | | 280 | | | | | | | |
| 315 | | 315 | | | | | | | |
| 355 | | 355 | | | | | | | |
| 400 | | 400 | | | | | | | |
| 450 | | 450 | | | | | | | |
| D70.011_80240 | 80 | 240 | 14 | 120 | 40 | 215 | 130 | 160 | 75 |
| 280 | | 280 | | | | | | | |
| 315 | | 315 | | | | | | | |
| 355 | | 355 | | | | | | | |
| 400 | | 400 | | | | | | | |
| 450 | | 450 | | | | | | | |
| 500 | | 500 | | | | | | | |

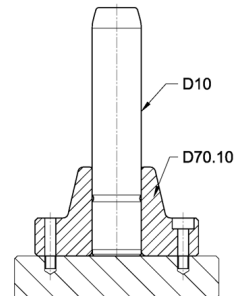
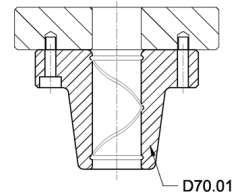
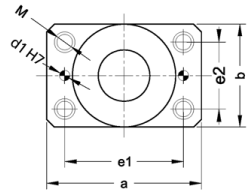
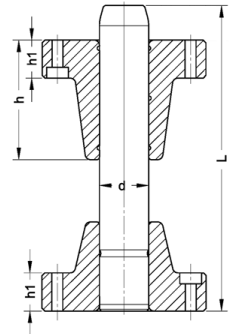

| Ød | M |
|----|----|
| 40 | 12 |
| 50 | 14 |
| 63 | 16 |
| 80 | 20 |

D70.021

Bronzlu Döküm Set / Guide Bearing Set with Bronze

Malzeme - Material : GG25 / Bronze / Asil Çelik 1.1213 (Cf 53)
 Sertlik - Hardness : 62 ± 2 HRC
 Isil İşlem - Heat Treatment: İndüksiyon (Induction)



| Sipariş Kodu | Ø d | L | d1 | h | h1 | a | b | e1 | e2 |
|---------------|-----|-----|----|-----|----|-----|-----|-----|----|
| D70.021_40180 | 40 | 180 | 10 | 77 | 30 | 130 | 80 | 95 | 45 |
| 220 | | 220 | | | | | | | |
| 260 | | 260 | | | | | | | |
| 300 | | 300 | | | | | | | |
| 355 | | 355 | | | | | | | |
| 400 | | 400 | | | | | | | |
| D70.021_50200 | 50 | 200 | 10 | 95 | 35 | 160 | 96 | 118 | 55 |
| 240 | | 240 | | | | | | | |
| 280 | | 280 | | | | | | | |
| 315 | | 315 | | | | | | | |
| 355 | | 355 | | | | | | | |
| 400 | | 400 | | | | | | | |
| 450 | | 450 | | | | | | | |
| D70.021_63240 | 63 | 240 | 12 | 120 | 35 | 180 | 110 | 132 | 62 |
| 280 | | 280 | | | | | | | |
| 315 | | 315 | | | | | | | |
| 355 | | 355 | | | | | | | |
| 400 | | 400 | | | | | | | |
| 450 | | 450 | | | | | | | |
| D70.021_80240 | 80 | 240 | 14 | 120 | 40 | 215 | 130 | 160 | 75 |
| 280 | | 280 | | | | | | | |
| 315 | | 315 | | | | | | | |
| 355 | | 355 | | | | | | | |
| 400 | | 400 | | | | | | | |
| 450 | | 450 | | | | | | | |
| 500 | | 500 | | | | | | | |

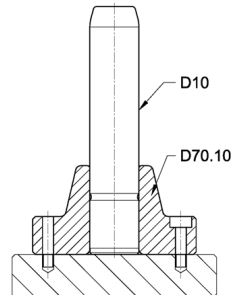
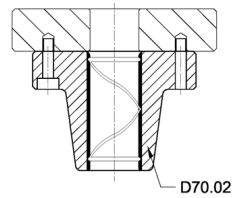
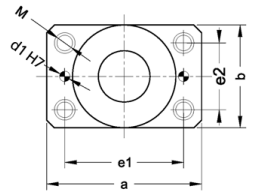
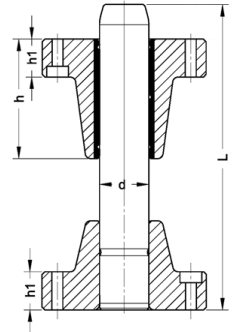

| Ød | M |
|----|----|
| 40 | 12 |
| 50 | 14 |
| 63 | 16 |
| 80 | 20 |

D70.031

Çelik Kaymalı Döküm Set / Guide Bearing Set with Steel

Malzeme - Material : GG25 / Asil Çelik 1.7131 (16MnCr5) / Asil Çelik 1.1213 (Cf 53)
 Sertlik - Hardness : 62 ± 2 HRC
 Isil İşlem - Heat Treatment: İndüksiyon (Induction)
 Sementasyon (Case Hardened)



| Sipariş Kodu | Ø d | L | d1 | h | h1 | a | b | e1 | e2 |
|---------------|-----|-----|----|-----|----|-----|-----|-----|----|
| D70.031_40180 | 40 | 180 | 10 | 77 | 30 | 130 | 80 | 95 | 45 |
| 220 | | 220 | | | | | | | |
| 260 | | 260 | | | | | | | |
| 300 | | 300 | | | | | | | |
| 355 | | 355 | | | | | | | |
| 400 | | 400 | | | | | | | |
| D70.031_50200 | 50 | 200 | 10 | 95 | 35 | 160 | 96 | 118 | 55 |
| 240 | | 240 | | | | | | | |
| 280 | | 280 | | | | | | | |
| 315 | | 315 | | | | | | | |
| 355 | | 355 | | | | | | | |
| 400 | | 400 | | | | | | | |
| 450 | | 450 | | | | | | | |
| D70.031_63240 | 63 | 240 | 12 | 120 | 35 | 180 | 110 | 132 | 62 |
| 280 | | 280 | | | | | | | |
| 315 | | 315 | | | | | | | |
| 355 | | 355 | | | | | | | |
| 400 | | 400 | | | | | | | |
| 450 | | 450 | | | | | | | |
| D70.031_80240 | 80 | 240 | 14 | 120 | 40 | 215 | 130 | 160 | 75 |
| 280 | | 280 | | | | | | | |
| 315 | | 315 | | | | | | | |
| 355 | | 355 | | | | | | | |
| 400 | | 400 | | | | | | | |
| 450 | | 450 | | | | | | | |
| 500 | | 500 | | | | | | | |

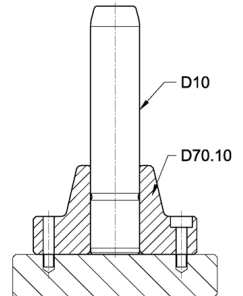
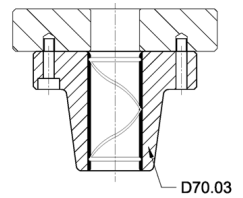
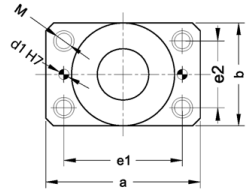
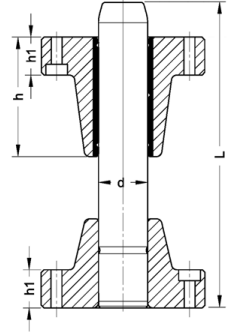

| Ød | M |
|----|----|
| 40 | 12 |
| 50 | 14 |
| 63 | 16 |
| 80 | 20 |

D70.041

Bilyalı Döküm Set / Guide Bearing Set with Ball Cage

Malzeme - Material : GG25 / Asil Çelik 1.3505 (100Cr6) / Asil Çelik 1.1213 (Cf 53)
 Sertlik - Hardness : 62 ± 2 HRC
 Isil İşlem - Heat Treatment: İndüksiyon (Induction)
 Sementasyon (Case Hardened)



| Sipariş Kodu | Ø d | L | d1 | h | h1 | a | b | e1 | e2 |
|---------------|-----|-----|----|-----|----|-----|-----|-----|----|
| D70.041_40180 | 40 | 180 | 10 | 77 | 30 | 130 | 80 | 95 | 45 |
| 220 | | 220 | | | | | | | |
| 260 | | 260 | | | | | | | |
| 300 | | 300 | | | | | | | |
| 355 | | 355 | | | | | | | |
| 400 | | 400 | | | | | | | |
| D70.041_50200 | 50 | 200 | 10 | 95 | 35 | 160 | 96 | 118 | 55 |
| 240 | | 240 | | | | | | | |
| 280 | | 280 | | | | | | | |
| 315 | | 315 | | | | | | | |
| 355 | | 355 | | | | | | | |
| 400 | | 400 | | | | | | | |
| 450 | | 450 | | | | | | | |
| D70.041_63240 | 63 | 240 | 12 | 120 | 35 | 180 | 110 | 132 | 62 |
| 280 | | 280 | | | | | | | |
| 315 | | 315 | | | | | | | |
| 355 | | 355 | | | | | | | |
| 400 | | 400 | | | | | | | |
| 450 | | 450 | | | | | | | |
| D70.041_80240 | 80 | 240 | 14 | 120 | 40 | 215 | 130 | 160 | 75 |
| 280 | | 280 | | | | | | | |
| 315 | | 315 | | | | | | | |
| 355 | | 355 | | | | | | | |
| 400 | | 400 | | | | | | | |
| 450 | | 450 | | | | | | | |
| 500 | | 500 | | | | | | | |

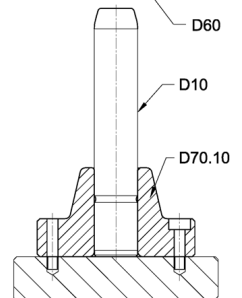
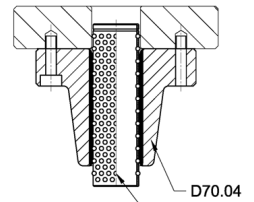
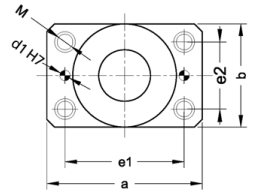
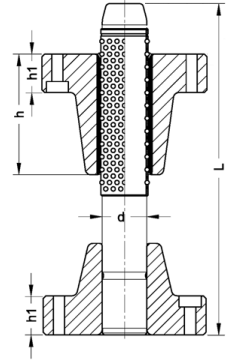

| Ød | M |
|----|----|
| 40 | 12 |
| 50 | 14 |
| 63 | 16 |
| 80 | 20 |

D70.051

Grafitli Döküm Set / Guide Bearing Set Non-Lubricant

Malzeme - Material : GG25 / SAE 430B / Asil Çelik 1.1213 (Cf 53)
 Sertlik - Hardness : 62± 2 HRC / HB≥180
 Isil İşlem - Heat Treatment: İndüksiyon (Induction)



| Sipariş Kodu | Ø d | L | d1 | h | h1 | a | b | e1 | e2 |
|---------------|-----|-----|----|-----|----|-----|-----|-----|----|
| D70.051_40180 | 40 | 180 | 10 | 77 | 30 | 130 | 80 | 95 | 45 |
| 220 | | 220 | | | | | | | |
| 260 | | 260 | | | | | | | |
| 300 | | 300 | | | | | | | |
| 355 | | 355 | | | | | | | |
| 400 | | 400 | | | | | | | |
| D70.051_50200 | 50 | 200 | 10 | 95 | 35 | 160 | 96 | 118 | 55 |
| 240 | | 240 | | | | | | | |
| 280 | | 280 | | | | | | | |
| 315 | | 315 | | | | | | | |
| 355 | | 355 | | | | | | | |
| 400 | | 400 | | | | | | | |
| 450 | | 450 | | | | | | | |
| D70.051_63240 | 63 | 240 | 12 | 120 | 35 | 180 | 110 | 132 | 62 |
| 280 | | 280 | | | | | | | |
| 315 | | 315 | | | | | | | |
| 355 | | 355 | | | | | | | |
| 400 | | 400 | | | | | | | |
| 450 | | 450 | | | | | | | |
| D70.051_80240 | 80 | 240 | 14 | 120 | 40 | 215 | 130 | 160 | 75 |
| 280 | | 280 | | | | | | | |
| 315 | | 315 | | | | | | | |
| 355 | | 355 | | | | | | | |
| 400 | | 400 | | | | | | | |
| 450 | | 450 | | | | | | | |
| 500 | | 500 | | | | | | | |

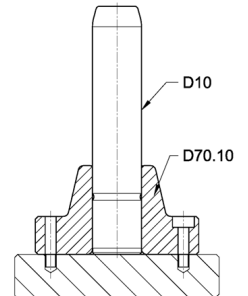
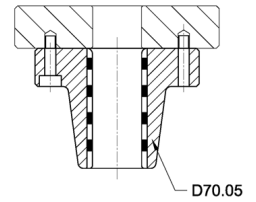
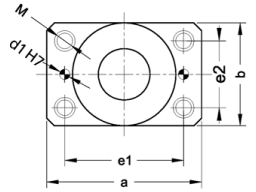
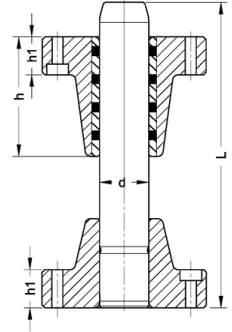

| Ød | M |
|----|----|
| 40 | 12 |
| 50 | 14 |
| 63 | 16 |
| 80 | 20 |

D71.02

Bronzlu Döküm Blok / Guide Bearing with Bronze

Malzeme - Material: GG25 / Bronze



| Sipariş Kodu | Ød | d1 | h | h1 | a | b | e1 | e2 |
|--------------|----|----|----|----|-----|----|-----|----|
| D71.02_40 | 40 | 10 | 70 | 25 | 130 | 75 | 100 | 44 |
| 50 | 50 | 10 | 85 | 25 | 155 | 90 | 125 | 60 |

| Ød | M |
|----|----|
| 40 | 12 |
| 50 | 12 |

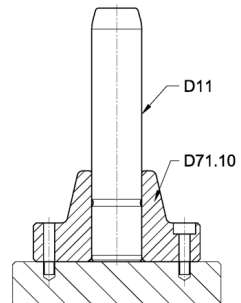
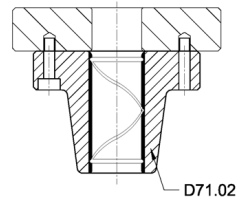
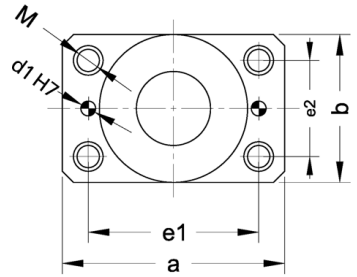
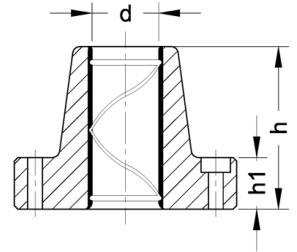

D71.05

Grafitli Döküm Blok / Guide Bearing Non-Lubricant

Malzeme - Material: GG25 / SAE 430B
Sertlik - Hardness : HB≥180



| Sipariş Kodu | Ød | d1 | h | h1 | a | b | e1 | e2 |
|--------------|----|----|----|----|-----|----|-----|----|
| D71.05_40 | 40 | 10 | 70 | 25 | 130 | 75 | 100 | 44 |
| 50 | 50 | 10 | 85 | 25 | 155 | 90 | 125 | 60 |

| Ød | M |
|----|----|
| 40 | 12 |
| 50 | 12 |

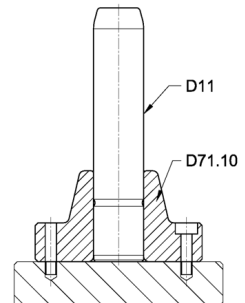
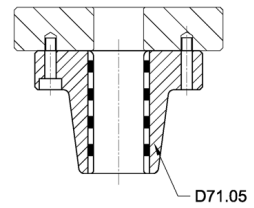
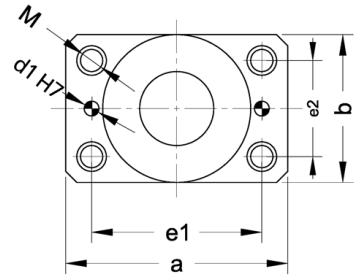
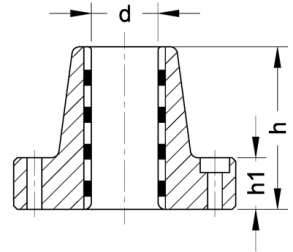

D71.10

Kolon Sabitleme Bloğu / Pillar Bearing

Malzeme - Material: GG25



| Sipariş Kodu | $\varnothing d$ | $d1$ | h | $h1$ | a | b | $e1$ | $e2$ |
|--------------|-----------------|------|-----|------|-----|-----|------|------|
| D71.10_40 | 40 | 10 | 50 | 25 | 130 | 75 | 100 | 44 |
| 50 | 50 | 10 | 70 | 25 | 155 | 90 | 125 | 60 |

| $\varnothing d$ | M |
|-----------------|----|
| 40 | 12 |
| 50 | 12 |

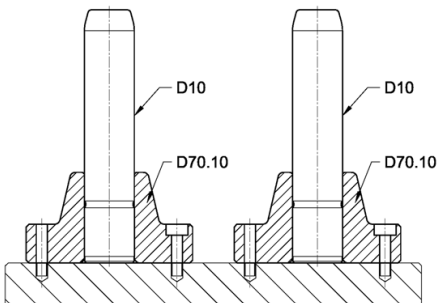
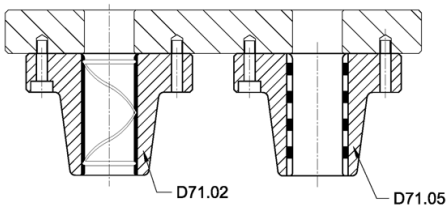
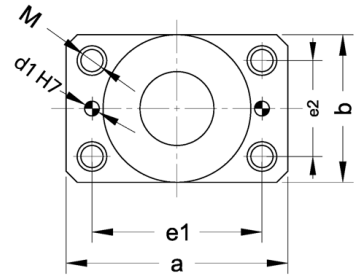
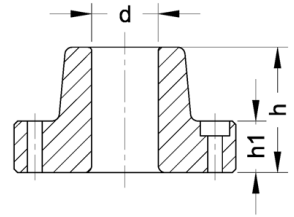

D71.021

Bronzlu Döküm Set / Guide Bearing Set with Bronze

Malzeme - Material : GG25 / Bronze / Asil Çelik 1.1213 (Cf 53)
 Sertlik - Hardness : 62± 2 HRC
 Isil İşlem - Heat Treatment : İndüksiyon (Induction)



| Sipariş Kodu | Ø d | L | d1 | h | h1 | a | b | e1 | e2 |
|---------------|-----|-----|----|----|----|-----|----|-----|----|
| D71.021_40160 | 40 | 160 | 10 | 70 | 25 | 130 | 75 | 100 | 44 |
| 180 | | 180 | | | | | | | |
| 200 | | 200 | | | | | | | |
| 225 | | 225 | | | | | | | |
| 250 | | 250 | | | | | | | |
| 280 | | 280 | | | | | | | |
| D71.10_40 | 40 | | 10 | 50 | 25 | 130 | 75 | 100 | 44 |
| D71.021_50160 | 50 | 160 | 10 | 85 | 25 | 155 | 90 | 125 | 60 |
| 180 | | 180 | | | | | | | |
| 200 | | 200 | | | | | | | |
| 225 | | 225 | | | | | | | |
| 250 | | 250 | | | | | | | |
| 280 | | 280 | | | | | | | |
| 315 | | 315 | | | | | | | |
| D71.10_50 | 50 | | 10 | 70 | 25 | 155 | 90 | 125 | 60 |

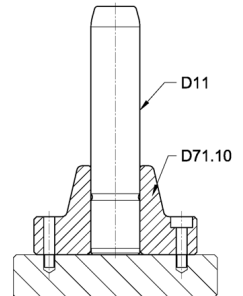
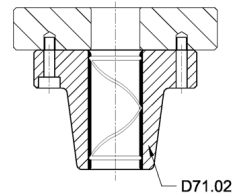
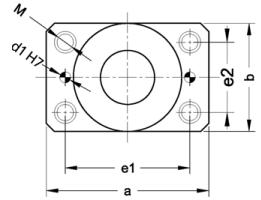
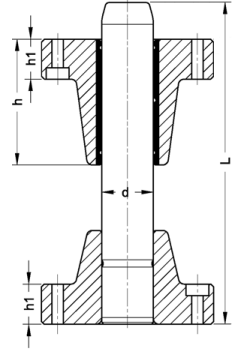

| Ød | M |
|----|----|
| 40 | 12 |
| 50 | 12 |

D71.051

Grafitli Döküm Set / Guide Bearing Set Non-Lubricant

Malzeme - Material : GG25 / SAE 430B / Asil Çelik 1.1213 (Cf 53)
 Sertlik - Hardness : 62 ± 2 HRC / HB \geq 180
 Isil İşlem - Heat Treatment: İndüksiyon (Induction)



| Sipariş Kodu | Ø d | L | d1 | h | h1 | a | b | e1 | e2 |
|---------------|-----|-----|----|----|----|-----|----|-----|----|
| D71.051_40160 | 40 | 160 | 10 | 70 | 25 | 130 | 75 | 100 | 44 |
| 180 | | 180 | | | | | | | |
| 200 | | 200 | | | | | | | |
| 225 | | 225 | | | | | | | |
| 250 | | 250 | | | | | | | |
| 280 | | 280 | | | | | | | |
| D71.10_40 | 40 | | 10 | 50 | 25 | 130 | 75 | 100 | 44 |
| D71.051_50160 | 50 | 160 | 10 | 85 | 25 | 155 | 90 | 125 | 60 |
| 180 | | 180 | | | | | | | |
| 200 | | 200 | | | | | | | |
| 225 | | 225 | | | | | | | |
| 250 | | 250 | | | | | | | |
| 280 | | 280 | | | | | | | |
| 315 | | 315 | | | | | | | |
| D71.10_50 | 50 | | 10 | 70 | 25 | 155 | 90 | 125 | 60 |

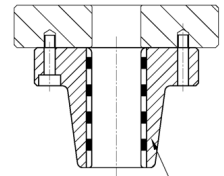
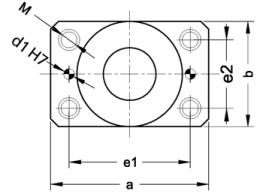
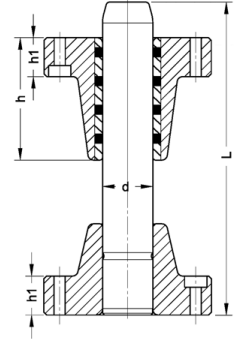

D71.05

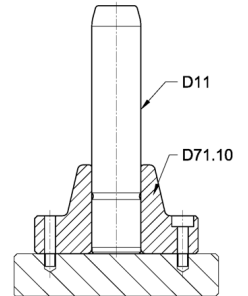

| Ød | M |
|----|----|
| 40 | 12 |
| 50 | 12 |

D19.01

Taşıma Mili / Lifting Pins CNOMO-Norm

Malzeme - Material : Çelik (Steel)



| Sipariş Kodu | d1 | PSA Mabec Code | Taşıma Kapasitesi Capacity (Kg) | d | L | L1 | a | S | s1 |
|--------------|----|----------------|---------------------------------|----|--------|-----|----|------|----|
| D19.01_32 | 32 | P953254770 | 6400 | 40 | 154 | 132 | 6 | 10 | 5 |
| 40 | 40 | P953255870 | 10000 | 50 | 197.75 | 170 | 8 | 12.5 | 6 |
| 50 | 50 | P953256670 | 16000 | 63 | 247.6 | 212 | 10 | 16 | 8 |
| 63 | 63 | P953257470 | 25000 | 80 | 309 | 265 | 12 | 20 | 10 |

Warning!
In utilisation for turnover the load is supported from two pins only.

Dikkat!
Kalıp çevirme için kullanılırken yükleme sadece iki pim ile yapılmalıdır.

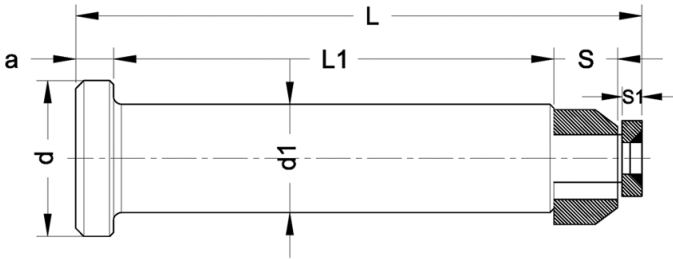

D19.02

Taşıma Mili / Lifting Pins

Malzeme - Material: Çelik (Steel)



| Sipariş Kodu | g | Taşıma Kapasitesi Capacity (Kg) | d | L | L1 | d1 | a | s |
|--------------|----|------------------------------------|----|-------|-----|------|---|------|
| D19.02_16 | 16 | 1200 | 25 | 102.5 | 77 | 15.6 | 6 | 11.5 |
| 21 | 21 | 2000 | 30 | 113.5 | 86 | 20.6 | 6 | 13.5 |
| 26 | 26 | 4000 | 35 | 128.5 | 100 | 25.6 | 6 | 13.5 |
| 34 | 34 | 8000 | 43 | 166.5 | 135 | 33 | 6 | 15.5 |
| 44 | 44 | 14000 | 53 | 215.5 | 175 | 43 | 8 | 20.5 |

Dikkat!**Kalıp çevirme için kullanılırken yükleme sadece iki pim ile yapılmalıdır.****Warning!**

In utilisation for turnover the load is supported from two pins only.

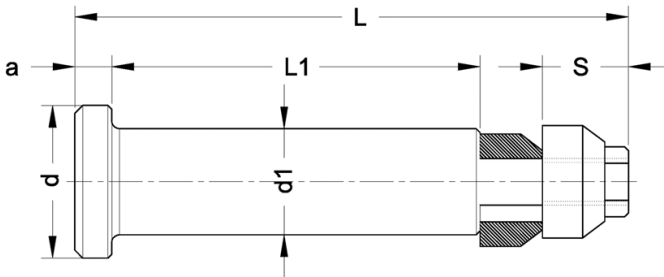
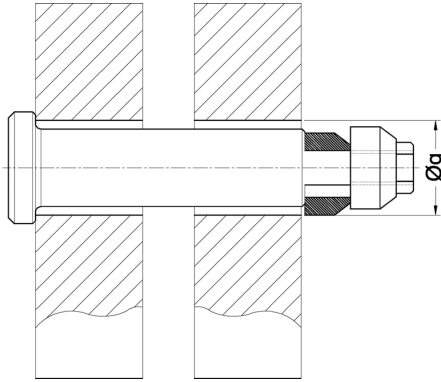

D19.03

Taşıma Mili / Lifting Pins

Malzeme - Material: Çelik (Steel)



| Sipariş Kodu | FORD CODE WDX2270 | Ø d1 | Taşıma Kapasitesi Capacity (Kg) | d | a | L | L1 |
|--------------|----------------------|---------|------------------------------------|----|----|-------|-----|
| D19.03_35 | 01035 | 35 | 3200 | 45 | 12 | 162.5 | 125 |
| 50 | 01050 | 50 | 8000 | 63 | 12 | 227.5 | 190 |
| 63 | 01063 | 63 | 12500 | 75 | 12 | 317.5 | 280 |
| 80 | 01080 | 80 | 31500 | 95 | 12 | 357.5 | 320 |

Dikkat!**Kalıp çevirme için kullanılırken yükleme sadece iki pim ile yapılmalıdır.****Warning!**

In utilisation for turnover the load is supported from two pins only.

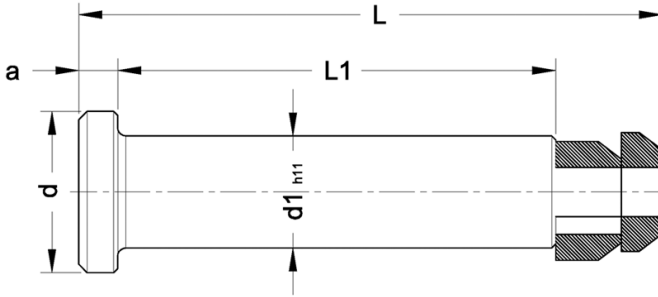

D19.50

Emniyet Pimi / Pad Retainer Pin

Malzeme - Material: CK45



| Sipariş Kodu | Ø | | PSA MABEC CODE | RENAULT MABEC CODE | L1 | M |
|--------------|----|-----|-------------------|-----------------------|----|-----|
| D19.50_20081 | 20 | 81 | Z000 400 337 | R100 306 188 | 19 | M8 |
| 25081 | 25 | 81 | Z000 400 338 | R100 306 190 | 19 | M8 |
| 25098 | 25 | 98 | Z000 400 339 | R100 306 191 | 19 | M8 |
| 32103 | 32 | 103 | Z000 400 487 | R100 306 194 | 26 | M8 |
| 32148 | 32 | 148 | Z000 400 342 | R100 306 198 | 26 | M8 |
| 40132 | 40 | 132 | Z000 400 345 | R100 306 201 | 33 | M10 |
| 40192 | 40 | 192 | Z000 400 346 | R100 306 204 | 33 | M10 |
| 50165 | 50 | 165 | Z000 400 349 | R100 306 207 | 41 | M10 |
| 50220 | 50 | 220 | Z000 400 350 | R100 306 209 | 41 | M10 |
| 63210 | 63 | 210 | Z000 400 353 | R100 306 210 | 51 | M12 |
| 63250 | 63 | 250 | Z000 400 354 | R100 306 213 | 51 | M12 |
| 80210 | 80 | 210 | Z000 400 846 | R100 357 232 | 51 | M12 |

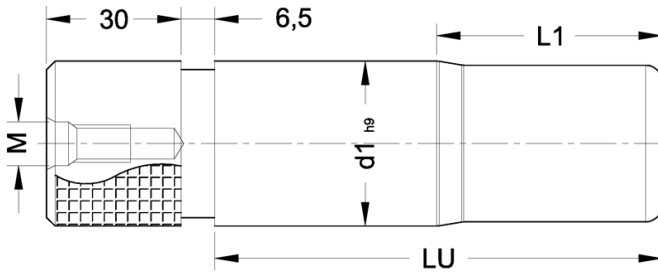

D12.01

Kolon Tutucu Flanş / Clamping Flange - AFNOR

Malzeme - Material : CK45

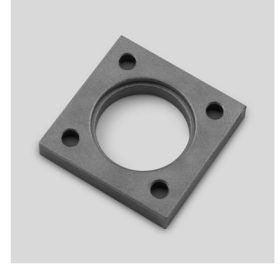

| Sipariş Kodu | PSA Mabec Code | RENAULT Mabec Code | Ø | | | | | | | | |
|--------------|----------------|--------------------|-----|-----|-----|----|----|----|-----|-----|-----|
| | | | A | B | G | H | J | D | C | E | F |
| D12.01_025 | Z000 248 844 | P483 784 100 | 25 | 28 | 6.6 | 11 | 7 | 10 | 2.7 | 45 | 31 |
| 032 | P446 932 711 | P483 784 600 | 32 | 37 | 6.6 | 11 | 7 | 10 | 4.2 | 56 | 36 |
| 040 | P446 932 701 | P483 795 100 | 40 | 45 | 6.6 | 11 | 7 | 12 | 4.2 | 70 | 50 |
| 050 | P446 932 702 | P483 795 401 | 50 | 55 | 9 | 16 | 9 | 14 | 4.2 | 80 | 55 |
| 063 | P446 932 703 | P483 795 801 | 63 | 70 | 11 | 18 | 11 | 18 | 6.2 | 100 | 70 |
| 080 | P446 932 704 | P483 796 001 | 80 | 87 | 13 | 22 | 14 | 20 | 6.2 | 110 | 80 |
| 100 | | P483 796 401 | 100 | 107 | 13 | 22 | 14 | 20 | 6.2 | 140 | 100 |

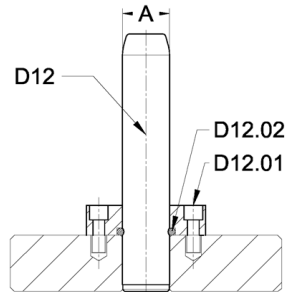
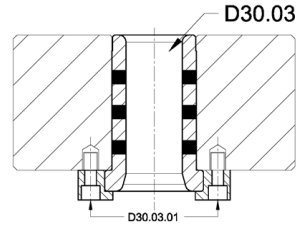
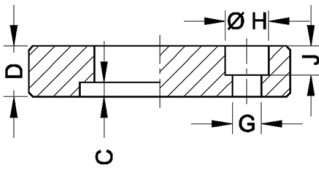
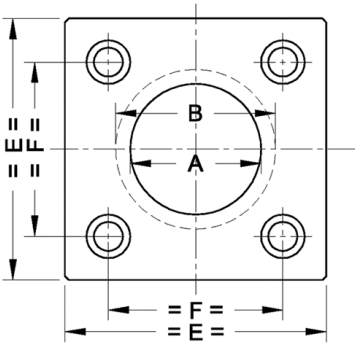

D12.02

Tutucu Halka / Retaining Ring - AFNOR

Malzeme - Material : 1040



| Sipariş Kodu | RENAULT Mabec Code | Ø | | |
|--------------|--------------------|-----|------|-----|
| | | A | D1 | D2 |
| D12.02_025 | P446 180 200 | 25 | 22.5 | 2.5 |
| 032 | P446 180 300 | 32 | 28 | 4 |
| 040 | P446 180 400 | 40 | 36 | 4 |
| 050 | P446 180 500 | 50 | 46 | 4 |
| 063 | P446 180 600 | 63 | 57 | 6 |
| 080 | P446 180 700 | 80 | 74 | 6 |
| 100 | P446 180 800 | 100 | 94 | 6 |

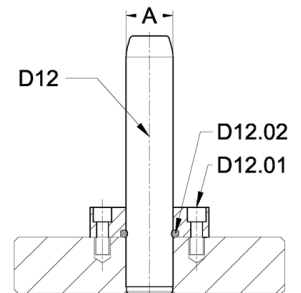
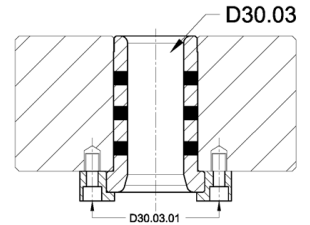
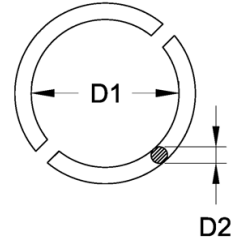

D30.03.01

Burç Tutucu Flanş / Retaining Flange - AFNOR

Malzeme - Material : CK45



| | | | Ø | | | | | | | | | | | |
|---------------|----------------|--------------------|-----|-----|-----|-----|----|----|----|-----|----|----|------|------|
| Sipariş Kodu | PSA Mabec Code | RENAULT Mabec Code | A | A1 | B | C | D | E | F | G | H | K | J | L |
| D30.03.01_025 | | M321 534 500 | 25 | 32 | 41 | 72 | 10 | 5 | 7 | 6.6 | 12 | 20 | | 20 |
| 032 | P446 932 717 | M321 544 501 | 32 | 40 | 51 | 80 | 12 | 6 | 7 | 6.6 | 12 | 21 | | 25 |
| 040 | P446 932 712 | M321 548 501 | 40 | 50 | 61 | 100 | 12 | 8 | 7 | 6.6 | 12 | 14 | 41 | 38.5 |
| 050 | P446 932 713 | M321 552 601 | 50 | 63 | 72 | 125 | 16 | 10 | 9 | 9 | 16 | 17 | 49 | 46 |
| 063 | P446 932 714 | M321 556 601 | 63 | 80 | 91 | 140 | 20 | 12 | 11 | 11 | 18 | 17 | 57.5 | 55 |
| 080 | P446 932 715 | M321 560 601 | 80 | 100 | 113 | 180 | 25 | 16 | 13 | 14 | 22 | 20 | 72 | 70 |
| 100 | | M321 562 700 | 100 | 125 | 141 | 200 | 32 | 20 | 13 | 14 | 22 | 25 | 85 | 81 |

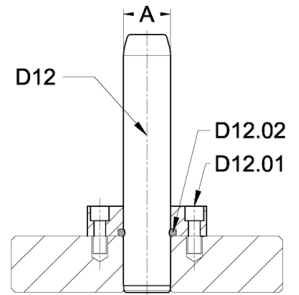
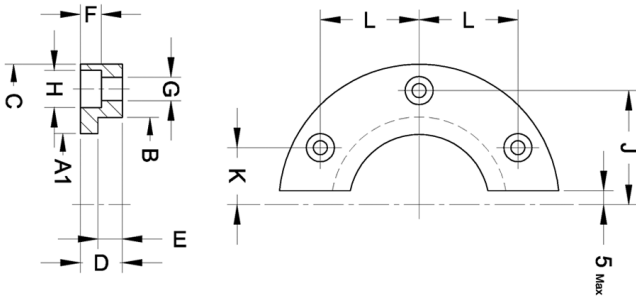
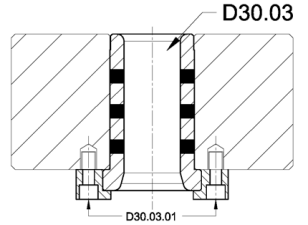

D90

Bağlama Pabucu
Pillar & Bush Clamp

Sertlik - Hardness : 40-42 HRC

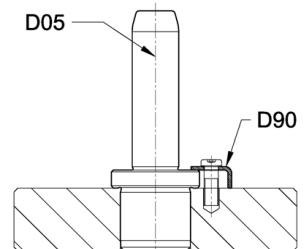
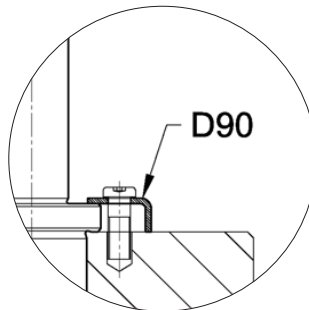
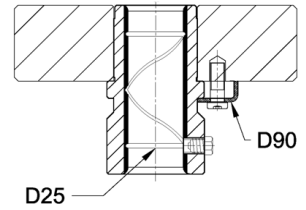
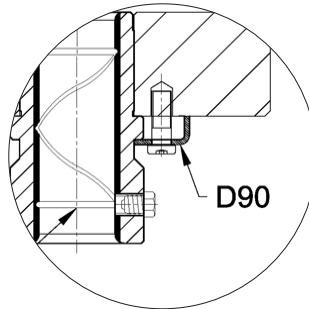
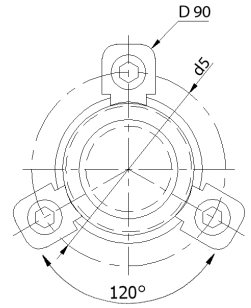
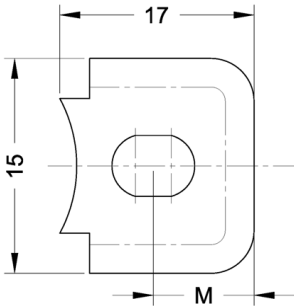
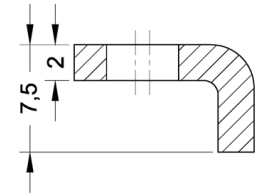
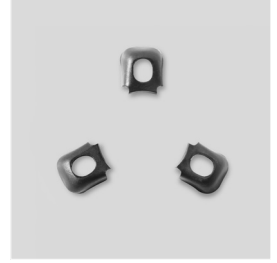

D90.01

Bağlama Pabucu
Pillar & Bush Clamp

Sertlik - Hardness : 40-42 HRC
DIN 9832



| Sipariş Kodu | FORD CODE | BMW CODE | PSA Mabec Code | D1 | L1 | L2 | L3 | L4 | L5 | L6 | L7 | D2 | D3 |
|--------------|--------------|--------------------|----------------|--|----|----|----|-----|----|------|------|----|----|
| D90.01_01 | WDX1360 0901 | B2 2978 11 2168834 | | 25 32 40 50 | 20 | 20 | 10 | 6.3 | 5 | 7 | 12.5 | 11 | 7 |
| D90.01_02 | WDX1360 0902 | B2 2978 11 2168842 | Z000263005 | 63 80 100 125 160 | 32 | 32 | 16 | 10 | 10 | 11.5 | 21 | 17 | 11 |
| D90.01_03 | WDX1360 1001 | | | 25 32 40 50 63 80 100 125 | 32 | 32 | 16 | 6 | 10 | 11.5 | 21 | 17 | 11 |

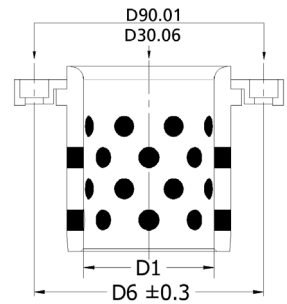
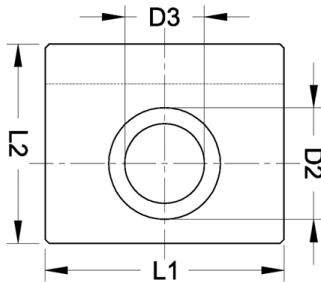
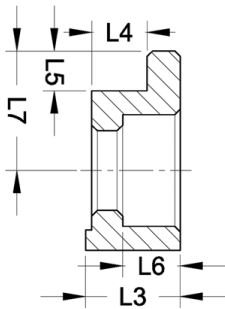

Teknik Bilgiler

Neden Kaymalı Sistemlerde Kolonlar için Cf 53 (1.1213) malzeme kullanıyoruz ?

- Karbon miktarı yüksektir. Dolayısıyla ısıtma işlemi esnasında yüksek sertliklere kolaylıkla ulaşabilir.
- Çekme kopma mukavemeti yüksektir. Darbeye daha dayanıklıdır.
- Sürtünmelere karşı yüksek aşınma dayanımı vardır.

İndüksiyon Derinlikleri

Piyasada indüksiyon derinliğinin fazla olması ile kolonun daha dayanımlı olacağı konusunda büyük bir yanılgı vardır. Tam tersine indüksiyon derinliği ne kadar dengeli olursa kırılma direnci karşı dayanım o kadar çok olur. Yılların verdiği tecrübe ve araştırmalarımız sonucunda elde ettiğimiz değerlere göre kolonlarımızda aşağıdaki çizelgede gösterilen indüksiyon derinliklerini uygulamaktayız.

| Ø Çap | Derinlik mm |
|---------|-------------|
| 12 - 14 | 1,0 - 1,5 |
| 16 - 20 | 1,2 - 2,0 |
| 25 - 30 | 1,5 - 2,5 |
| 40 - 50 | 1,8 - 2,8 |
| 63 - 80 | 2 - 3 |

D70 - D71 Yeni Döküm Bloklarımız

Sac kesme ve form kalıplarının sökölüp takılma süresini azaltır. Kalıp üzerinde kolon ve burç delikleri açılmayacağından kalıbın yapım süresini kısaltarak işçilik maliyetlerini düşürür. Alt ve üst döküm blokların içine geçirilmiş burç ve pim takımından oluşur. Çelik geçme, bronz geçme, bilyalı ve sadece döküm gövdeden oluşan çeşitleri vardır.

Yeni Konik Kilitleme

Çift taraflı bağlama özelliğinden dolayı daha hızlı montaj ve daha hassas ayar imkanı sağlamaktadır.

Yeni Sinterli Burçlar

D32 - D33 kesme ve form kalıplarında merkezleme elemanı olarak kullanılır. Çalışmaya başlarken bir defa yağlanır, sonrasında yağlamaya ihtiyaç yoktur. İçerisindeki grafit özelliğinden dolayı kaygan bir yüzey oluşturur. Sarma riski yoktur.

Bilyalı Sistemlerin Kullanım Alanları ve Uyarılar

- Erkek ve dişinin arasındaki kesme boşluğunun az olduğu hassas kalıplarda
- Dakikada baskı adedinin 200'ün üzerine çıktığı yerlerde
- Kesilen malzemenin 0,5 mm kalınlığının altına düştüğü durumlarda
- Enjeksiyon kalıplarının itici plakalarında kullanılır.

Bilyalı sistemler kullanılırken dikkat edilmesi gereken en önemli husus; kullanılan bilyaların toleransların çok dar olması gerekmektedir. Çünkü bilyalarda değişen her ölçü kolon ve burç çalışma toleransındaki hatayı ikiye katlar. Biz bilyalarımızın tamamını +0,001 mm toleransında ithal ediyoruz. Dolayısıyla farklı bir bilya kafesinin bizim kolon ve burçlarımızla sağlıklı çalışmadığı yapılan testler neticesinde tespit edilmiştir.

Kullandığımız Toleranslar Neye Göre Belirlenir?

Ürünlerimiz toleransları ve çalışma boşlukları DIN 7161'e göre belirlenmiştir. Fakat bu toleranslardaki değerler bazı ölçülerde bizi tatmin etmediği için daraltılmıştır. Kataloğumuzdaki görünen bu değerler DIN 7161'in tecrübelerimizle daraltılmış halleridir.

Yüzey Pürüzlülüğünün Önemi

Yüzey pürüzlüğü birbirleriyle çalışan parçalar açısından en önemli konulardan birisidir. Bir örnek verecek olursak; bozuk yolda ilerleyen bir araba ile düzgün yolda ilerleyen arabanın ilerlemesi arasındaki fark gibi... Biz ürünlerimizin uzun ömürlü ve aşınmaya karşı maksimum dayanımlı olması için yüzey pürüzlüğüne çok önem veriyoruz. Kolonların çalışma yüzeylerindeki pürüzlüğü Rz 1,5 ve altı, diğer yüzeylerde ise Rz 3 olarak standartlaştırdık. Unutulmamalıdır ki düşük değerdeki yüzey pürüzlüğü ürünün ömrünü uzatır, korozyona karşı dayanımını artırır ve sürtünmenin çok düşük seviyelere inmesiyle mükemmel çalışma şartı sağlar.

Kullanıcılara Tavsiyeler

Dikkat edilmesi gereken en önemli konulardan biri de kolon ve burçların yerlerine montajdır. Kesinlikle montaj esnasında **sıkı çakma** yapılmamalıdır. Bu hem kolon ve burçlarda hasar meydana getirir, hem de taşlanmış oturma yüzeyleri bozulacağı için diklik elde etmek çok güçleşir. Kolon ve burçlar uygun toleranslarda yerlerine takılıp **bağlama papuçları** vasıtasıyla sabitlenmelidir. Bu şekilde bağlama doğrusalığın ve dikliğinin sağlanabilmesi ve malzemelerin uzun ömürlü olabilmesi için en doğru yöntemdir.

Piyasada sıkça yapılan hatalardan birisi de yağ kanalı olmayan 2 ürünün bir arada kullanılmasıdır. Kullanılan ürünlerin bir tanesinde kesinlikle yağ kanalı olmalıdır. Aksi taktirde yüzeyde yağ filmi oluşmadığı için kısa sürede ısınmalar meydana gelmekte ve birbirlerini sarmaya başlayacaklardır.

Kolon ve burçlar satın alınırken her ikisinin de aynı marka olmasına azami dikkat gösterilmelidir. Çünkü farklı kolon ve burçlarda farklı taşlama toleransları olabileceğinden hem montaj hem de kullanım esnasında büyük problemler yaşanabilir.

DİKKAT

- DELTA, kataloğundaki ürün çeşit ve toleranslarında değişiklik yapma hakkını saklı tutar.
- Ürünlerimizin ambalaj ömrü yaklaşık 2 yıldır.
- DELTA ürünlerin tüm çeşitleri ömür testine tabi tutulmaktadır.
- Katalogdaki çizim ve grafikler DELTA'ya aittir, izinsiz çoğaltılamaz.

| Kod | Ürün / Product | No | Kod | Ürün / Product | No |
|-----------|---|-------|------------------|--|--------|
| D00 | Kolon / Guide Pillar | 38-39 | D100.01_00250 | Gazlı Yay / Gas Springs | 82 |
| D01 | Kolon / Guide Pillar | 26-28 | D100.01_00500 | Gazlı Yay / Gas Springs | 84 |
| D01D | Kolon / Guide Pillar | 30-32 | D100.01_00750 | Gazlı Yay / Gas Springs | 86 |
| D02 | Kademeli Kolon / Guide Pillar | 2-11 | D100.01_01500 | Gazlı Yay / Gas Springs | 88 |
| D03 | Kuyruklu Kolon / Tailed Guide Pillar | 14-21 | D100.01_03000 | Gazlı Yay / Gas Springs | 90 |
| D05 | Kolon / Guide Pillar | 40-41 | D100.01_05000 | Gazlı Yay / Gas Springs | 92 |
| D08 | Kolon / Guide Pillar | 33 | D100.02_00320 | Gazlı Yay / Gas Springs | 94 |
| D09 | Kolon / Guide Pillar | 34 | D100.02_00350 | Gazlı Yay / Gas Springs | 95 |
| D10 | Kolon / Guide Pillar | 42 | D100.02_00500 | Gazlı Yay / Gas Springs | 96 |
| D11 | Kolon / Guide Pillar | 43 | D100.02_00750 | Gazlı Yay / Gas Springs | 97 |
| D12 | Kolon / Guide Pillar AFNOR | 44 | D100.02_01000 | Gazlı Yay / Gas Springs | 99 |
| D12.01 | Kolon Tutucu Flanş / Clamping Flange AFNOR | 129 | D100.02_01500 | Gazlı Yay / Gas Springs | 101 |
| D12.02 | Tutucu Halka / Retaining Ring AFNOR | 130 | D100.02_02400 | Gazlı Yay / Gas Springs | 103 |
| D13.01 | Kolon / Guide Pillar | 45 | D100.02_04200 | Gazlı Yay / Gas Springs | 105 |
| D13.02 | Kolon / Guide Pillar | 46 | D100.02_06600 | Gazlı Yay / Gas Springs | 107 |
| D14 | Kolon / Guide Pillar | 47-48 | D100.50.01_00250 | Gazlı Yay Bağla. Pabuçu / Gas Springs Mounting Clamp | 83 |
| D15 | Kolon / Guide Pillar | 49-50 | D100.50.01_00500 | Gazlı Yay Bağla. Pabuçu / Gas Springs Mounting Clamp | 85-98 |
| D19.01 | Taşıma Mili / Lifting Pins | 125 | D100.50.01_00750 | Gazlı Yay Bağla. Pabuçu / Gas Springs Mounting Clamp | 87-100 |
| D19.02 | Taşıma Mili / Lifting Pins | 126 | D100.50.01_01000 | Gazlı Yay Bağla. Pabuçu / Gas Springs Mounting Clamp | 102 |
| D19.03 | Taşıma Mili / Lifting Pins | 127 | D100.50.01_01500 | Gazlı Yay Bağla. Pabuçu / Gas Springs Mounting Clamp | 89-104 |
| D19.50 | Emniyet Mili / Pad Retainer Pin | 128 | D100.50.01_03000 | Gazlı Yay Bağla. Pabuçu / Gas Springs Mounting Clamp | 91-106 |
| D20 | Burç / Guide Bush | 12-13 | D100.50.01_05000 | Gazlı Yay Bağla. Pabuçu / Gas Springs Mounting Clamp | 93-108 |
| D21 | Kuyruklu Burç / Tailed Guide Bush | 22-23 | D100.50.02_00250 | Gazlı Yay Bağla. Pabuçu / Gas Springs Mounting Clamp | 83 |
| D22 | Flanşlı Burç / Middle Flanged Bush | 29 | D100.50.02_00500 | Gazlı Yay Bağla. Pabuçu / Gas Springs Mounting Clamp | 85-98 |
| D22B | Bilyalı Burç / Guide Bush with Ball Cage | 35 | D100.50.02_00750 | Gazlı Yay Bağla. Pabuçu / Gas Springs Mounting Clamp | 87-100 |
| D23 | Burç / Guide Bush | 51 | D100.50.02_01500 | Gazlı Yay Bağla. Pabuçu / Gas Springs Mounting Clamp | 89-104 |
| D24 | Burç / Guide Bush | 52 | D100.50.02_03000 | Gazlı Yay Bağla. Pabuçu / Gas Springs Mounting Clamp | 91-106 |
| D25 | Bronzlu Burç / Guide Bush with Bronze | 53 | D100.50.02_05000 | Gazlı Yay Bağla. Pabuçu / Gas Springs Mounting Clamp | 93-108 |
| D26 | Bronzlu Burç / Guide Bush with Bronze | 54 | | | |
| D27 | Burç / Guide Bush | 57 | | | |
| D28 | Burç / Guide Bush | 58 | | | |
| D30.01 | Grafiteli Burç / Oilless Guide Bush | 63 | | | |
| D30.02 | Grafiteli Burç / Oilless Guide Bush | 64 | | | |
| D30.03 | Grafiteli Burç / Oilless Guide Bush AFNOR | 65 | | | |
| D30.03.01 | Burç Tutucu Flanş / Retaining Flange AFNOR | 131 | | | |
| D30.04 | Grafiteli Burç / Oilless Guide Bush | 66-68 | | | |
| D30.05 | Grafiteli Burç / Oilless Guide Bush | 69-70 | | | |
| D30.06 | Grafiteli Burç / Oilless Guide Bush | 71 | | | |
| D32 | Sinterli Burç / Guide Bush with Sintered | 55 | | | |
| D33 | Sinterli Burç / Guide Bush with Sintered | 56 | | | |
| D40 | Tespit Burcu / Centring Sleeves | 24-25 | | | |
| D50 | Konik Kilitleme / Locating Unit | 36 | | | |
| D60 | Bilyalı Kafes / Ball Cage | 59-61 | | | |
| D60.01 | Bilyalı Kafes Tutucusu / Helical Spring For Ball Cage Retention | 62 | | | |
| D70.01 | Döküm Blok / Guide Bearing | 109 | | | |
| D70.011 | Döküm Set / Guide Bearing Set | 115 | | | |
| D70.02 | Bronzlu Döküm Blok / Guide Bearing with Bronze | 110 | | | |
| D70.021 | Bronzlu Döküm Set / Guide Bearing Set with Bronze | 116 | | | |
| D70.03 | Çelik Kaymalı Döküm Blok / Guide Bearing with Steel | 111 | | | |
| D70.031 | Çelik Kaymalı Döküm Set / Guide Bearing Set with Steel | 117 | | | |
| D70.04 | Bilyalı Döküm Blok / Guide Bearing with Ball Cage | 112 | | | |
| D70.041 | Bilyalı Döküm Set / Guide Bearing Set with Ball Cage | 118 | | | |
| D70.05 | Grafiteli Döküm Blok / Guide Bearing Non-Lubricant | 113 | | | |
| D70.051 | Grafiteli Döküm Set / Guide Bearing Set Non-Lubricant | 119 | | | |
| D70.10 | Kolon Sabitleme Bloğu / Pillar Bearing | 114 | | | |
| D71.02 | Bronzlu Döküm Blok / Guide Bearing with Bronze | 120 | | | |
| D71.021 | Bronzlu Döküm Set / Guide Bearing Set with Bronze | 123 | | | |
| D71.05 | Grafiteli Döküm Blok / Guide Bearing Non-Lubricant | 121 | | | |
| D71.051 | Grafiteli Döküm Set / Guide Bearing Set Non-Lubricant | 124 | | | |
| D71.10 | Kolon Sabitleme Bloğu / Pillar Bearing | 122 | | | |
| D80.01 | Grafiteli Sürtünme Plakası / Wear Plate with Graphite Insert | 72 | | | |
| D80.02 | Grafiteli Sürtünme Plakası / Wear Plate with Graphite Insert | 73 | | | |
| D80.03 | Grafiteli Sürtünme Plakası / Wear Plate with Graphite Insert | 74-75 | | | |
| D80.04 | Grafiteli Sürtünme Plakası / Wear Plate with Graphite Insert | 76 | | | |
| D80.15 | Çelik Sürtünme Plakası Sliding Pads | 77-78 | | | |
| D88 | Düz Kam / Horizontal Slide Cam Unit | 79 | | | |
| D90 | Bağlama Pabucu / Pillar and Bush Clamp | 132 | | | |
| D90.01 | Bağlama Pabucu / Pillar and Bush Clamp | 133 | | | |



mükemmel
bir kalıp için **DELTA®**
kullanın



• İstanbul



• Bursa



• İzmir

• Kayseri

• Ankara

• Eskişehir

• Konya



www.deltakalip.com

DELTA®

Tevfik Fikret Sk. No.39 Soğanlık, Kartal - İstanbul / Turkey
Tel: 0090 216 452 00 33 (Pbx) Fax: 0090 216 452 69 81
deltakalip@deltakalip.com



KOSGEB

KÜÇÜK VE ORTA ÖLÇEKLİ İŞLETMELERİN GELİŞTİRME
VE DESTEKLEME İDARESİ BAŞKANLIĞI

www.kosgeb.gov.tr